

# JVC



**CD RECEIVER**

**KD-SH9750/KD-SH9700**

**RECEPTOR CON CD**

**KD-SH9750/KD-SH9700**

**RECEPTEUR CD**

**KD-SH9750/KD-SH9700**

ENGLISH

ESPAÑOL

FRANÇAIS

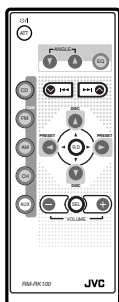
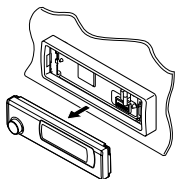

**PiCT**

**WMA  
MP3**

**BBE<sup>®</sup>  
DIGITAL**

**COMPACT  
disc  
DIGITAL AUDIO  
TEXT**

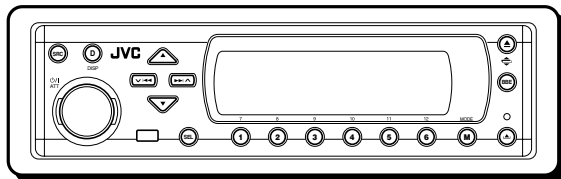

- This unit is equipped with the display demonstration. To cancel it, see page 8.
- Esta unidad está equipada con demostración en la pantalla. Para cancelarla, consulte la página 8.
- Cet appareil est équipé d'une fonction de démonstration des affichages. Pour l'annuler, référez-vous à la page 8.

For installation and connections, refer to the separate manual.  
Para la instalación y las conexiones, refiérase al manual separado.  
Pour l'installation et les raccordements, se référer au manuel séparé.

## **INSTRUCTIONS**

**MANUAL DE INSTRUCCIONES**  
**MANUEL D'INSTRUCTIONS**

**For customer Use:**

Enter below the Model No. and Serial No. which are located on the top or bottom of the cabinet. Retain this information for future reference.

Model No. \_\_\_\_\_

Serial No. \_\_\_\_\_

LVT1004-001A

[J/C]

**INFORMATION (For U.S.A.)**

This equipment has been tested and found to comply with the limits for a Class B digital device, pursuant to Part 15 of the FCC Rules. These limits are designed to provide reasonable protection against harmful interference in a residential installation. This equipment generates, uses, and can radiate radio frequency energy and, if not installed and used in accordance with the instructions, may cause harmful interference to radio communications. However, there is no guarantee that interference will not occur in a particular installation. If this equipment does cause harmful interference to radio or television reception, which can be determined by turning the equipment off and on, the user is encouraged to try to correct the interference by one or more of the following measures:

- Reorient or relocate the receiving antenna.
- Increase the separation between the equipment and receiver.
- Connect the equipment into an outlet on a circuit different from that to which the receiver is connected.
- Consult the dealer or an experienced radio/TV technician for help.

**IMPORTANT FOR LASER PRODUCTS****Precautions:**

1. CLASS 1 LASER PRODUCT
2. **CAUTION:** Invisible laser radiation when open and interlock failed or defeated. Avoid direct exposure to beam.
3. **CAUTION:** Do not open the top cover. There are no user-serviceable parts inside. Leave all servicing to qualified service personnel.
4. **CAUTION:** This CD player uses invisible laser radiation, however, is equipped with safety switches to prevent radiation emission when unloading CDs. It is dangerous to defeat the safety switches.
5. **CAUTION:** Use of controls, adjustments or performance of procedures other than those specified herein may result in hazardous radiation exposure.

**How to reset your unit**

Press the reset button on the control panel using a ball-point pen or similar tool. This will reset the built-in microcomputer.

**Note:**

*Your preset adjustments—such as preset channels or sound adjustments—will also be erased.*

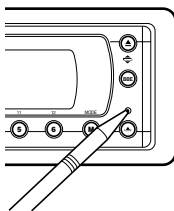
**CAUTION:**

NEVER insert your finger in between the control panel and the unit, as it may get caught or hurt. (See page 45.)

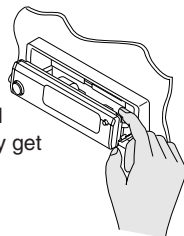
**BEFORE USE****\*For safety....**

- Do not raise the volume level too much, as this will block outside sounds, making driving dangerous.
- Stop the car before performing any complicated operations.

**\*Temperature inside the car....**

If you have parked the car for a long time in hot or cold weather, wait until the temperature in the car becomes normal before operating the unit.

Thank you for purchasing a JVC product. Please read all instructions carefully before operation, to ensure your complete understanding and to obtain the best possible performance from the unit.

# CONTENTS

How to reset your unit .....	2	<b>SOUND ADJUSTMENTS</b> .....	<b>30</b>
<b>LOCATION OF THE BUTTONS</b> .....	<b>4</b>	Performing the basic sound settings .....	30
Control panel .....	4	Making sounds natural—BBE Digital .....	31
Remote controller .....	5	<b>GRAPHIC DISPLAYS</b> .....	<b>32</b>
Preparing the remote controller .....	6	Downloading images and animations .....	33
<b>BASIC OPERATIONS</b> .....	<b>7</b>	Deleting unwanted files .....	35
Turning on the power .....	7	Activating the downloaded images and animations .....	37
Canceling the display demonstration .....	8	<b>OTHER MAIN FUNCTIONS</b> .....	<b>39</b>
Setting the clock .....	8	Changing the general settings (PSM) .....	39
Selecting the level meter .....	9	Selecting the dimmer mode .....	43
<b>RADIO OPERATIONS</b> .....	<b>10</b>	Assigning names to the sources .....	44
Listening to the radio .....	10	Changing the control panel angle .....	45
Storing stations in memory .....	12	Detaching the control panel .....	46
Tuning in to a preset station .....	13	<b>CD CHANGER OPERATIONS</b> .....	<b>47</b>
Changing the display pattern .....	14	Playing discs .....	47
<b>CD OPERATIONS</b> .....	<b>15</b>	Locating a folder on a disc .....	50
About MP3 and WMA discs .....	15	Selecting a disc/folder/track using the name lists .....	51
Playing a disc .....	15	Selecting playback modes .....	52
Locating a particular portion on a track .....	17	<b>EXTERNAL COMPONENT OPERATIONS</b> .....	<b>54</b>
Locating a track on a disc .....	18	Playing an external component .....	54
Locating a folder on a disc .....	19	<b>ADDITIONAL INFORMATION</b> .....	<b>55</b>
Selecting a folder and a track using the name lists .....	21	<b>TROUBLESHOOTING</b> .....	<b>56</b>
Selecting playback modes .....	22	<b>MAINTENANCE</b> .....	<b>58</b>
Prohibiting disc ejection .....	23	Handling discs .....	58
Changing the display pattern .....	24	<b>SPECIFICATIONS</b> .....	<b>59</b>
<b>DSP OPERATIONS</b> .....	<b>25</b>		
Selecting the DSP modes .....	25		
<b>EQUALIZER OPERATIONS</b> .....	<b>28</b>		
Selecting preset sound modes (iEQ: intelligent equalizer) .....	28		
Storing your own sound modes .....	29		

**CAUTION on Volume Setting:**

Discs produce very little noise compared with other sources. If the volume level is adjusted for the tuner, for example, the speakers may be damaged by the sudden increase in the output level. Therefore, lower the volume before playing a disc and adjust it as required during playback.

**Caution:**

If the temperature inside the car is below 0°C (32°F), the movement of animation and text scroll will be halted on the display to prevent the display from being blurred.  (LOW TEMP.) indicator appears on the display.

When the temperature increases, and the operating temperature is resumed, these functions will start working again.



# LOCATION OF THE BUTTONS

ENGLISH

## Control panel

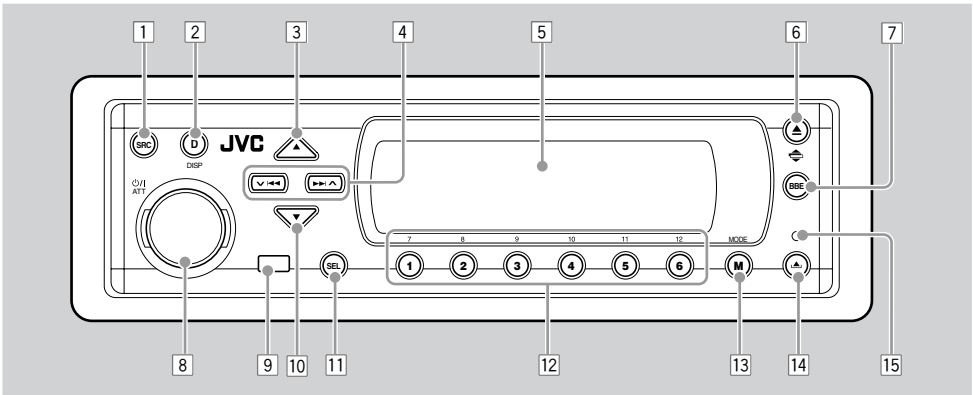

- 1 SRC (source) button
- 2 DISP (D) (display) button
- 3 ▲ (up) button
- 4 ▼ ◀▶▶▶ ▲ buttons
- 5 Display window
- 6 • ▲ (eject) button  
• ◀▶ (angle) button
- 7 BBE button
- 8 • ⏻/ATT (standby/on/attenuator) button  
• Control dial
- 9 Remote sensor
- 10 ▼ (down) button
- 11 SEL (select) button
- 12 Number buttons
- 13 MODE (M) button
- 14 ◀▶ (control panel release) button
- 15 Reset button

### Illumination Navigation for easy operations:

If you use MODE (M) or SEL (select), the display and some controls (such as the number buttons, ▼ ◀▶▶▶ ▲, ▲ / ▼, and control dial) enter the corresponding control mode, then the controls start flashing to lead you to the next operational steps. (Illumination Navigation)

- The display show how these buttons function during this period.

Ex. When you press number button 1 after pressing MODE (M), to operate the FM tuner.

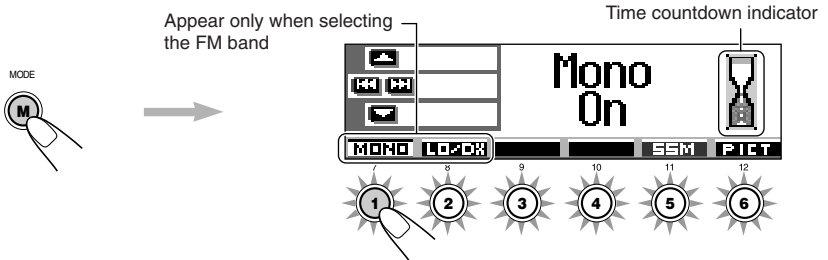

**To use these controls for original functions again**, wait until the controls stop flashing without using these controls.

- Pressing MODE (M) again also restores original functions. However, pressing SEL (select) makes the unit into a different mode.



# Remote controller

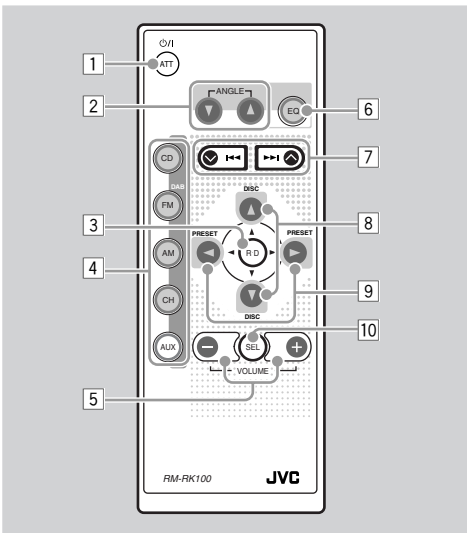

- 1 • Turns on the unit if pressed when the unit is turned off.
- Turns off the unit if pressed and held for a few seconds.
- Drops the volume level in a moment if pressed briefly.  
Press again to resume the volume.

- 2 Changes the angle of the control panel to four positions.

- 3 Skips to the root while listening to an MP3 disc.

- 4 • CD : Selects CD player.
  - FM : Selects FM tuner.
- Each time you press the button, FM band (FM1, FM2 and FM3) changes.

**Note:** Does not function as the DAB button.

- AM : Selects AM tuner.
- CH : Selects CD changer.\*1
- AUX : Selects the external component (LINE IN).\*2

- 5 \*3• Changes the volume.

- 6 Selects the sound (iEQ) mode.
- Each time you press the button, the sound (iEQ) mode changes.

- 7 • Searches stations while listening to the radio.
- Fast-forwards or reverses the track if pressed and held while listening to a disc.
- Skips to the beginning of the next track or goes back to the beginning of the current (or previous) tracks if pressed briefly while listening to a disc.
- 8 • Changes the disc number while listening to the CD changer. Each time you press and hold the button, the disc number changes, and the selected disc starts playing.
- Skips to the first track of a folder on a higher hierarchy level or on a lower hierarchy level if pressed briefly while listening to an MP3 or a WMA disc. (This does not function for WMA discs on the MP3-compatible CD changer).
- Adjusts the fader level on the fader/balance adjustment screen.
- 9 • Changes the preset channel number while listening to the radio. Each time you press the button, the preset channel number changes, and the selected station is tuned in.
- Skips to the first track of the next folder or the first track of the previous folder if pressed and held while listening to an MP3 or a WMA disc.
- Skips to the first track of the next folder or the first track of the previous folder on the same hierarchy level if pressed briefly while listening to an MP3 or a WMA disc. (This does not function for WMA discs on the MP3-compatible CD changer).
- Adjusts the balance level on the fader/balance adjustment screen.
- 10 \*3 Turns on or off the fader/balance adjustment screen. Then you can adjust them using the buttons explained above (8 and 9).

\*1 Without connecting the CD changer, you cannot select it as the source to play.

\*2 For KD-SH9750: If the "Line In" setting is changed to "Off," you cannot select "LINE IN" (see pages 40 and 42).

For KD-SH9700: To select "LINE IN," change the "Ext Input" setting to "Line In" (see pages 40 and 42).

\*3 These buttons do not function in the preferred setting mode (PSM) adjustment.

## Preparing the remote controller

Before using the remote controller:

- Aim the remote controller directly at the remote sensor on the main unit. Make sure there is no obstacle in between.

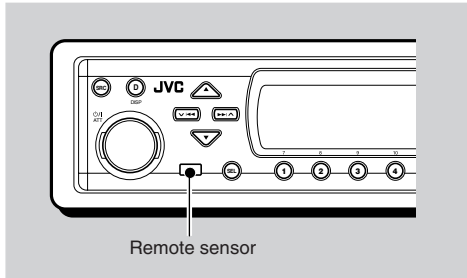

- Do not expose the remote sensor to strong light (direct sunlight or artificial lighting).

### Installing the battery

When the controllable range or effectiveness of the remote controller decreases, replace the battery.

#### 1. Remove the battery holder.

- 1) Push out the battery holder in the direction indicated by the arrow using a ball-point pen or a similar tool.
- 2) Remove the battery holder.

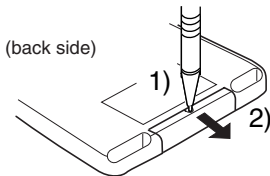

#### 2. Place the battery.

Slide the battery into the holder with the + side facing upwards so that the battery is fixed in the holder.

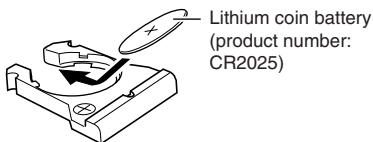

#### 3. Return the battery holder.

Insert again the battery holder pushing it until you hear a clicking sound.

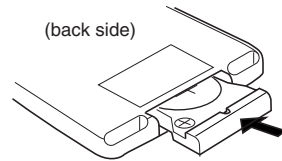

#### WARNING:

- Store the battery in a place where children cannot reach.  
*If a child accidentally swallows the battery, consult a doctor immediately.*
- Do not recharge, short, disassemble or heat the battery or dispose of it in a fire.  
*Doing any of these things may cause the battery to give off heat, crack or start a fire.*
- Do not leave the battery with other metallic materials.  
*Doing this may cause the battery to give off heat, crack or start a fire.*
- When throwing away or saving the battery, wrap it in tape and insulate; otherwise, the battery may start to give off heat, crack or start a fire.
- Do not poke the battery with tweezers or similar tools.  
*Doing this may cause the battery to give off heat, crack or start a fire.*

#### CAUTION:

*DO NOT leave the remote controller in a place (such as dashboards) exposed to direct sunlight for a long time. Otherwise, it may be damaged.*

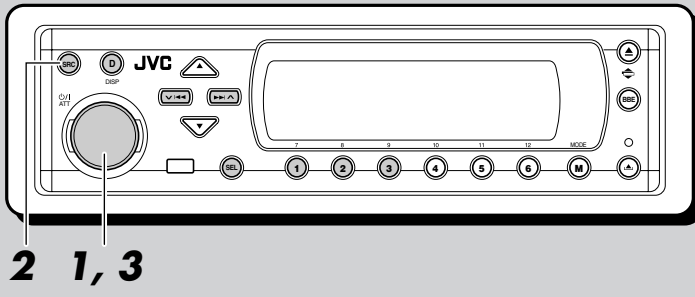

**Display indication:**  
If you have changed some PSM items (see page 40), the indications on the display you see may be different from those used in this manual.

## Turning on the power

### 1 Turn on the power.

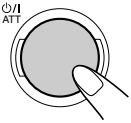

**Note on One-Touch Operation:**

When you select a source in step 2 below, the power automatically comes on. You do not have to press this button to turn on the power.

### 2 Select the source.



Each time you press the button, the source changes as follows.

For KD-SH9750:



For KD-SH9700:



\*1 If a disc is not in the loading slot, you cannot select CD as the source to play.

\*2 Without connecting the CD changer, you cannot select it as the source to play.

\*3 When "Line In" is set to "Off" in the PSM setting, you cannot select "LINE IN" as the source (see page 42).

\*4 To select "LINE IN" as the source, select "Line in" for the "Ext Input" setting on page 42.

### 3 Adjust the volume.

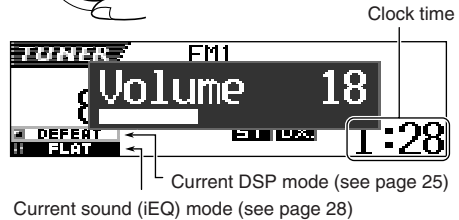
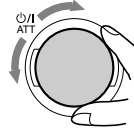

Current DSP mode (see page 25)  
Current sound (iEQ) mode (see page 28)

### 4 Select the DSP mode and sound mode as you want.

#### To drop the volume in a moment

Press **O/I ATT** briefly while listening to any source. "ATT" starts flashing on the display, and the volume level will drop in a moment.

To resume the previous volume level, press the button briefly again.

- If you turn the control dial, you can also restore the sound.

#### To turn off the power

Press **O/I ATT** for more than 1 second.

- If you turn off the power while listening to a disc, playback will start from where playback has been stopped previously, next time you turn on the power.

## Canceling the display demonstration

When shipped from the factory, display demonstration has been activated, and starts automatically when no operations are done for about 20 seconds.

- It is recommended to cancel the demonstration before you use the unit for the first time.

To cancel the display demonstration, follow the procedure below:

- Press and hold SEL (select) for more than 2 seconds so that one of the PSM items appears on the display. (PSM: see page 40.)



- Press number button 1 to select—“MOVIE”—Movie category of the PSM settings.

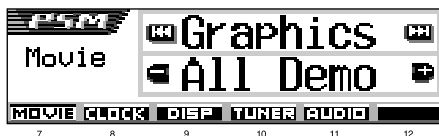

The “Graphics” setting screen appears on the display.

- Select “Off.”

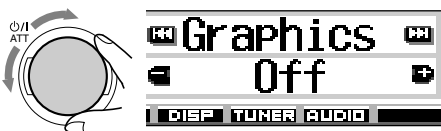

- Finish the setting.



To activate the display demonstration, repeat the same procedure and select “All Demo” or “Int Demo” in step 3.

- For more details, see “To show the graphics on the display—Graphics” on page 41.

## Setting the clock

You can also set the clock system to 24 hours or 12 hours.

- Press and hold SEL (select) for more than 2 seconds so that one of the PSM items appears on the display. (PSM: see page 40.)



- Press number button 2 to select “CLOCK”—Clock category of the PSM settings.



The “Clock Hr” setting screen appears on the display.

- Adjust the hour.

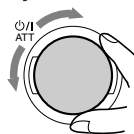

- Set the minute.

- Select “Clock Min (minute).”
- Adjust the minute.

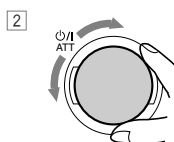
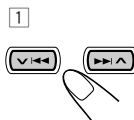





### 5 Set the clock system.

- 1 Select "24H/12H."
- 2 Adjust "24Hours" or "12Hours."



### 4 Select the level meter pattern you want.

As you turn the control dial, the level meters change as follows:

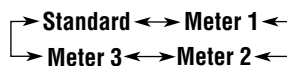

### 6 Finish the setting.



### 5 Finish the setting.



To check the current clock time when the unit is turned off, press DISP (D).

The power turns on and the clock time is shown for about 5 seconds, then the power turns off.

### Standard:

No level meter appears on the display. (Initially selected when shipped from the factory.)

## Selecting the level meter

You can show the level meters on the display while playing any source. This unit is equipped with three level meter patterns.

- 1 Press and hold SEL (select) for more than 2 seconds so that one of the PSM items appears on the display. (PSM: see page 40.)



- 2 Press number button 3 to select "DISP"—Display category of the PSM settings.



- 3 Select "Theme."

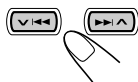

### Meter 1:

The left and right audio level meters appear.

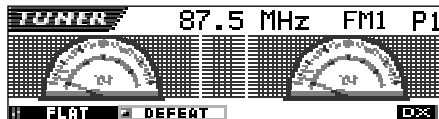

### Meter 2:

Level meters fluctuate horizontally from center to both sides as audio levels changes.



### Meter 3:

Signal waves fluctuate at the center and spread outward.

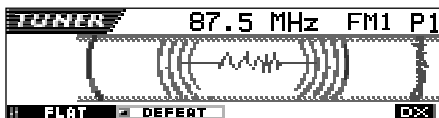



# RADIO OPERATIONS

ENGLISH

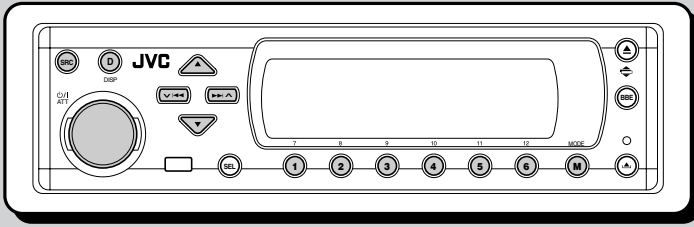

## Listening to the radio

You can use either automatic searching or manual searching to tune in to a particular station.

### Searching a station automatically: Auto search

#### 1 Select the band (FM1 – 3, AM).

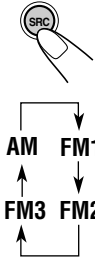

- 1 Press SRC (source) repeatedly to select the tuner.
- 2 Press and hold SRC for more than 1 second. The band indication on the display starts flashing.
- 3 Within about 5 seconds (while the band indication is flashing), press SRC again. Each time you press the button, the band changes.

Last received station of the selected band is tuned in.

If a name has been assigned to the station (see page 44), the assigned name appears.

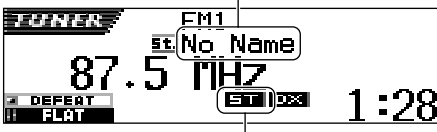

Lights up when receiving an FM stereo broadcast with sufficient signal strength.

#### Note:

This receiver has three FM bands (FM1, FM2, FM3). You can use any one of them to listen to an FM broadcast.

#### 2 Start searching a station.

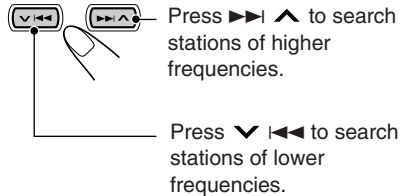

Ex. When the band is FM

When a station is received, searching stops.

**To stop searching before a station is received,** press the same button you have pressed for searching.

## To tune in FM stations only with strong signals—LO/DX (Local/Distant)

While searching FM stations (including SSM—see page 12), this unit stops searching whenever it detects signals (DX mode: The DX indicator is lit—initial setting). If received signals are weak, you may only hear noises.

By setting LO/DX to “Local,” you can make this unit detects only stations with sufficient signal strength.

- 1 Press MODE (M) while listening to an FM stereo broadcast. “Mode” appears on the display, and the number buttons start flashing.

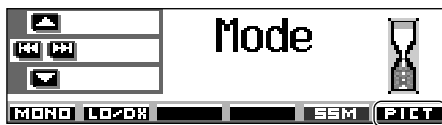

See page 33 for this function.

- 2 Press number button 2, while “Mode” is still on the display. Each time you press the button, the “LO/DX” setting alternates between “Local” and “DX.”

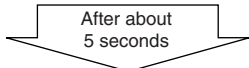

The display returns to the source indication screen.



LO indicator appears

## Searching a station manually: Manual search

- 1 Select the band (FM1 – 3, AM).



- 1 Press SRC (source) repeatedly to select the tuner.
- 2 Press and hold SRC for more than 1 second.
- 3 Within about 5 seconds, press SRC again. Each time you press the button, the band changes.

**Note:**

This receiver has three FM bands (FM1, FM2, FM3). You can use any one of them to listen to an FM broadcast.

- 2 Press and hold  $\blacktriangleright\blacktriangleright$   $\blacktriangle$  or  $\blacktriangleright\blacktriangleright$   $\blacktriangleleft$  until “Manual Search” appears on the display.



- 3 Tune in to a station you want while “Manual Search” is still on the display.

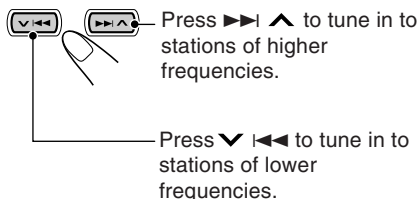

- If you release your finger from the button, the manual mode will automatically turn off after about 5 seconds.
- If you hold down the button, the frequency keeps changing until you release the button.



## When an FM stereo broadcast is hard to receive:

Set the FM reception mode to "Mono On."

1 Press MODE (M) while listening to an FM stereo broadcast. "Mode" appears on the display, and the number buttons start flashing.



2 Press number button 1, while "Mode" is still on the display. Each time you press the button, "Mono On" and "Mono Off" alternately appears.

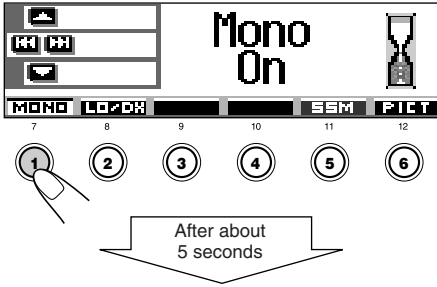

The display return to the source indication screen.

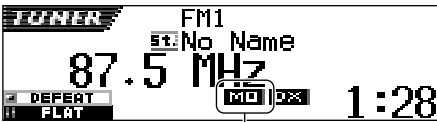

MO indicator appears

## Storing stations in memory

You can use one of the following two methods to store broadcasting stations in memory.

- Automatic preset of FM stations: SSM (Strong-station Sequential Memory)
- Manual preset of both FM and AM stations

### FM station automatic preset: SSM

You can preset 6 local FM stations in each FM band (FM1, FM2 and FM3).

#### 1 Select the FM band (FM1 – 3) you want to store FM stations into.



- 1 Press SRC (source) repeatedly to select the tuner.
- 2 Press and hold SRC for more than 1 second. The band indication on the display starts flashing.

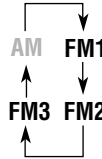

- 3 Within about 5 seconds (while the band indication is flashing), press SRC again. Each time you press the button, the band changes.

#### 2 Start SSM.



- 1 Press MODE (M). "Mode" appears on the display, and the number buttons start flashing.



- 2 Press and hold number button 5 until "– SSM –" appears.

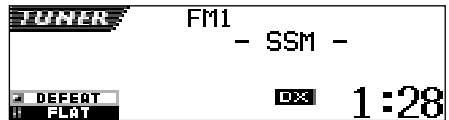

Local FM stations with the strongest signals are searched and stored automatically in the band number you have selected (FM1, FM2 or FM3). These stations are preset in the number buttons — No.1 (lowest frequency) to No.6 (highest frequency).

When automatic preset is over, the station stored in number button 1 will be automatically tuned in.

## Manual preset

You can preset up to 6 stations in each band (FM1, FM2, FM3 and AM) manually.

Ex.: Storing an FM station of 88.3 MHz into the preset number 1 of the FM1 band.

### 1 Select the band (FM1 – 3, AM) you want to store stations into (in this example, FM1).

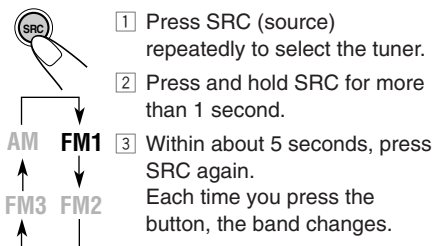

### 2 Tune in to a station (in this example, of 88.3 MHz).

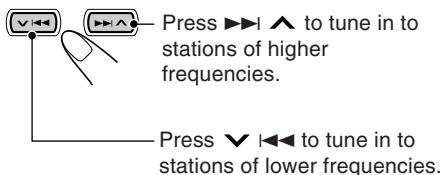

### 3 Press and hold the number button (in this example, 1) for more than 2 seconds.

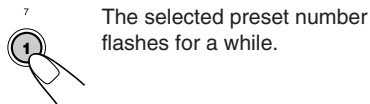

### 4 Repeat the above procedure to store other stations into other preset numbers.

## Notes:

- A previously preset station is erased when a new station is stored in the same preset number.
- Preset stations are erased when the power supply to the memory circuit is interrupted (for example, during battery replacement). If this occurs, preset the stations again.

## Tuning in to a preset station

You can easily tune in to a preset station. Remember that you must store stations first. If you have not stored them yet, see “Storing stations in memory” on pages 12 and 13.

### Selecting a preset station directly

#### 1 Select the band (FM1 – 3, AM).

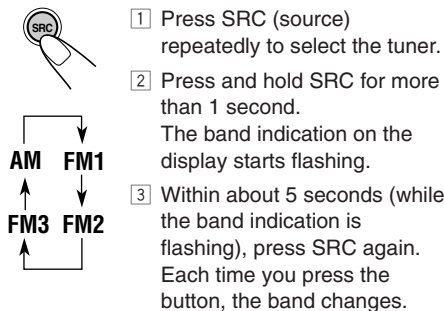

#### 2 Select the number (1 – 6) for the preset station you want.

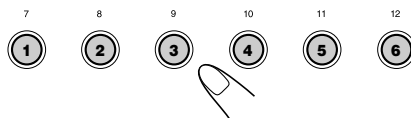

## Note:

You can also use the **▲** (up) or **▼** (down) button on the unit to select the next or previous preset stations. Each time you press the **▲** (up) or **▼** (down) button, the next or previous preset station is tuned in.



## Selecting a preset station using the preset station list

If you forget what stations are stored in what preset numbers, you can check the preset station list, then select your desired station on the list.

### 1 Select the band (FM1 – 3, AM).

- Press SRC (source) repeatedly to select the tuner.
- Press and hold SRC for more than 1 second.
- Within about 5 seconds, press SRC again. Each time you press the button, the band changes.

### 2 Press and hold ▲ (up) or ▼ (down) until the preset station list for the current band (FM1, FM2, FM3, or AM) appears on the display.

The currently received station will be highlighted on the display.

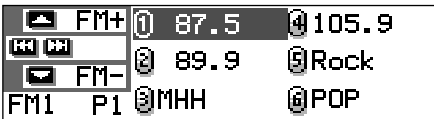

**Notes:**

- If one of FM band preset station lists (FM1, FM2, or FM3) is shown on the display, you can show the other lists by pressing ▲ (up) or ▼ (down).
- If a name has been assigned to a station (see page 44), it will be shown instead of the station frequency.

### 3 Select the number (1 – 6) for the preset station you want.

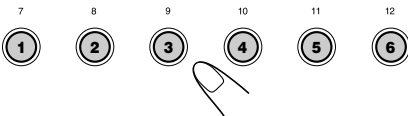

## Changing the display pattern

By pressing DISP (D), you can change the information shown on the display.



Each time you press the button, the display patterns change as follows:

• Initial display pattern:

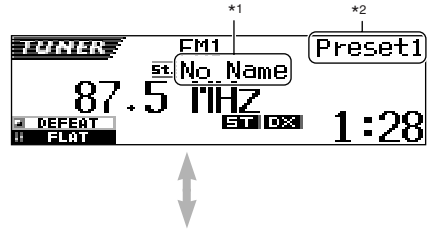

• Assigned station name is emphasized:



\*1 If a name has been assigned to a station, it will be shown instead of "No Name."

\*2 Appears only when selecting a preset station.

### If the sound quality decreases and the stereo effect is lost while listening to an FM station

In some areas, adjacent stations may interfere with each other. If this interference occurs, this unit can automatically reduce this interference noise (initial factory setting). However, in this case, the sound quality will be degraded and the stereo effect will be also lost.

If you do not want to degrade the sound quality and to lose the stereo effect, rather than to eliminate the interference noise, see "To change the FM tuner selectivity—IF Filter" on page 42.

### When using this unit in an area other than North or South America

You need to change the AM/FM channel intervals. See "To change the AM/FM channel intervals—Area" on page 42.

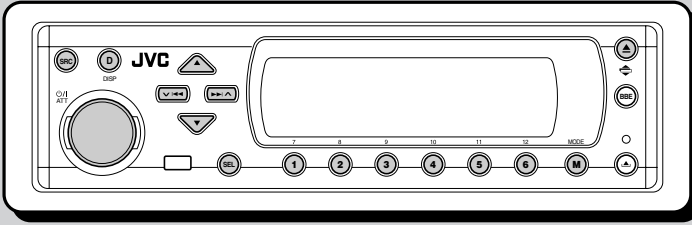

This unit has been designed to reproduce CDs, CD-Rs (Recordable), CD-RWs (Rewritable), and CD Texts.

- This unit is also compatible with MP3 and WMA discs. For details about these discs, refer to “A Guide to MP3/WMA” (separate volume).

## About MP3 and WMA discs

MP3 and WMA (Windows Media® Audio) “tracks” (word “file” is not used to indicate MP3 or WMA files, “track” is used in this manual) are recorded in “folders.”

During recording, the tracks and folders can be arranged in a way similar to arranging files and folders of computer data.

“Root” is similar to the root of a tree. Every track and folder can be linked to and be accessed from the root.

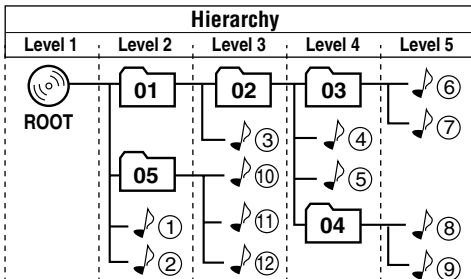

- 01 : Folders and their playback order
- ① : MP3/WMA tracks and their playback order

## Playing a disc

- 1 Open the control panel.

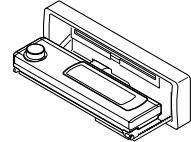

- 2 Insert a disc into the loading slot.

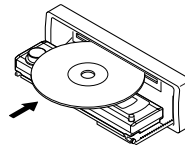

The unit draws the disc, the control panel goes back to the previous position (see page 45), and playback starts automatically.

All tracks will be played repeatedly until you stop playback.

### Notes:

- MP3 or WMA discs require a longer readout time. (It differs due to the complexity of the folder/track configuration.)
- For details on playable discs and other related information, see page 58.
- Microsoft and Windows Media are either registered trademarks or trademarks of Microsoft Corporation in the United States and/or other countries.



• Display indications when inserting an audio CD or a CD Text:

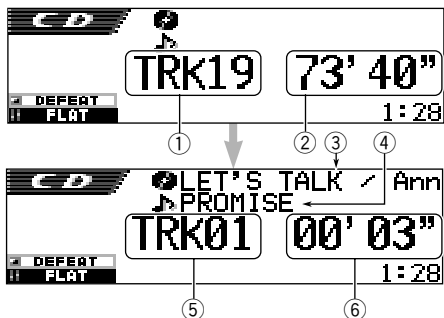

- ① Total track number
- ② Total playback time of the disc
- ③ Disc title/performer (if no title is recorded or assigned\*, "No Name" appears.)
- ④ Track title (if no title is recorded, "No Name" appears.)
- ⑤ Current track number
- ⑥ Elapsed playing time of the current track

\* If a name has been assigned to the audio CD (see page 44), it will be shown on the display.

• Display indications when inserting an MP3 or a WMA disc

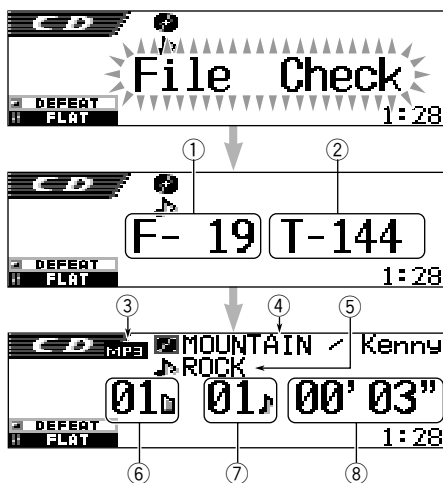

- ① Total folder number
- ② Total track number
- ③ Disc type—MP3 or WMA
- ④ Album name/performer (or folder name when "Tag" is set to "Off"—see page 41, or when no Tag is recorded)
- ⑤ Track title (or track name when "Tag" is set to "Off"—see page 41, or when no Tag is recorded)
- ⑥ Current folder number
- ⑦ Current track number
- ⑧ Elapsed playing time of the current track

Notes:

- When a disc is already in the loading slot, selecting "CD" as the source starts disc play.
- The unit cannot read or play an MP3 track without the extension code <mp3>, and a WMA track without the extension code <wma>.
- When a disc is inserted upside down, the disc automatically ejects.
- If you change the source, playback also stops (without ejecting the disc).  
Next time you select "CD" as the source, disc play starts from where it has been stopped previously.

To stop play and eject the disc

Press .

Playback stops, the control panel moves down, and the disc automatically ejects from the loading slot.

If you change the source, the disc play also stops (without ejecting the disc this time).

To return the control panel to its previous position, press again.

- If you keep the loading slot open for about 1 minute, (beeps sound when the "Beep" setting is turned "On"—see page 42) the control panel returns to its previous position.

Be careful not to get the disc or your finger caught in between the control panel and the unit.



**Note:**

If the ejected disc is not removed within 15 seconds, the disc is automatically inserted again into the loading slot to prevent it from dust. (Disc will not play this time.)

**What is ImageLink**

When an MP3 or a WMA folder includes an image <jml> file edited by Image Converter (supplied in the CD-ROM), you can show the image on the display while the tracks in the folder are played back.

- While reading an image <jml> file, no sounds come out (the preset image of a coffee cup is shown on the display during this period).

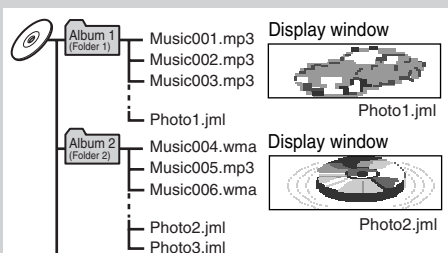

If there are more than one <jml> file in a folder, a <jml> file with younger playback order number will be shown on the display (in the above example, "Photo2.jml" will be used for Album 2).

To activate ImageLink, follow the procedure below

- See also "Changing the general settings (PSM)" on page 39.
- 1 Press and hold SEL (select) for more than 2 seconds so that one of the PSM items appears on the display.
  - 2 Press number button 1 to select—"MOVIE"—Movie category of the PSM settings.  
The "Graphics" setting screen appears on the display.
  - 3 Turn the control dial to select "ImageLink."
  - 4 Press SEL (select) to finish the setting.  
ImageLink starts functioning when the next folder starts playing.

**Note:**

ImageLink will not work in the following cases:

- If no <jml> file is included in an MP3/WMA folder.
- If Intro Scan is activated.
- If the source is changed to another from "CD," or
- If you turn off then on the unit while the preset image of a coffee cup is shown on the display.

## Locating a particular portion on a track

### To fast-forward or reverse the track

Press and hold , while playing a disc, to fast-forward the track.

Press and hold , while playing a disc, to reverse the track.

**Note:**

During this operation on an MP3 or WMA disc, you can only hear intermittent sounds. (The elapsed playing time also changes intermittently on the display.)

### To go to the next or previous tracks

Press briefly, while playing a disc, to go ahead to the beginning of the next track. Each time you press the button consecutively, the beginning of the next tracks is located and played back.

Press briefly, while playing a disc, to go back to the beginning of the current track. Each time you press the button consecutively, the beginning of the previous tracks is located and played back.



## Locating a track on a disc

### To go to a particular track directly (ONLY for CD and CD Text discs)

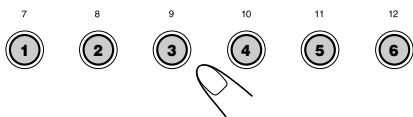

Press the number button corresponding to the track number to start its playback.

- To select a track number from 1 – 6:  
Press 1 (7) – 6 (12) briefly.
- To select a track number from 7 – 12:  
Press and hold 1 (7) – 6 (12) for more than 1 second.

### To go to a track quickly

- 1 Press MODE (M) while playing a disc.  
“Mode” appears on the display, and the number buttons and ▲ (up)/ ▼ (down) buttons start flashing.



While playing an audio CD or a CD Text disc:

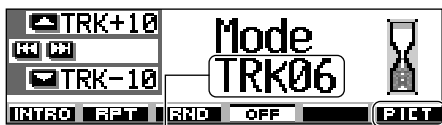

Current track number

See page 33 for this function.

While playing an MP3 or a WMA disc:

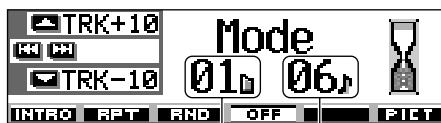

Current folder number

Current track number

- 2 Press ▲ (up) or ▼ (down), while “Mode” is still on the display. First time you press ▲ (up) or ▼ (down), the track skips to the nearest higher or lower track with a track number of multiple ten (ex. 10th, 20th, 30th).

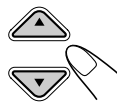

Then, each time you press the button, you can skip 10 tracks (see “How to go to the desired track quickly” that follows).

- After the last track, the first track will be selected, and vice versa.
- While playing an MP3 or a WMA disc, this operation is possible only within a folder.

### How to go to the desired track quickly

- Ex. 1: To select track number 32 while playing track number 6

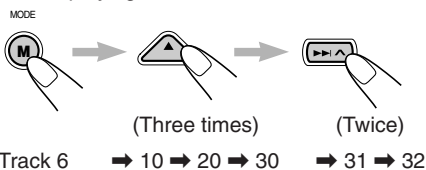

- Ex. 2: To select track number 8 while playing track number 36

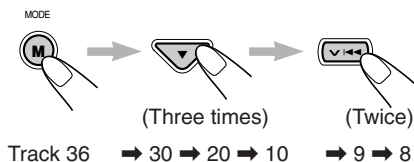



## Locating a folder on a disc

The following operations are only possible when playing an MP3 or a WMA disc.

### To go to a folder directly

#### IMPORTANT:

To directly select the folders using the number button(s), it is required that folders are assigned 2 digit numbers at the beginning of their folder names. (This can only be done during the recording of CD-Rs or CD-RWs.)

Ex.: If folder name is "01 ABC"

→ Press 1 to go to Folder "01 ABC."

If folder name is "1 ABC," pressing 1 does not work.

If folder name is "12 ABC"

→ Press and hold 6 (12) to go to Folder "12 ABC."

To skip to the next or previous folder (either on the same or different hierarchy levels)

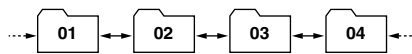

See the hierarchy diagram on page 15.

#### On the control panel:



Press ▲ (up) while playing a disc to skip to the next folder.



Each time you press the button consecutively, the next folder is located and the first track in the folder starts playing.

Press ▼ (down) while playing a disc to skip back to the previous folder.

Each time you press the button consecutively, the previous folder is located and the first track in the folder starts playing.

Press the number button corresponding to the folder number to start playing the first track in the selected folder.

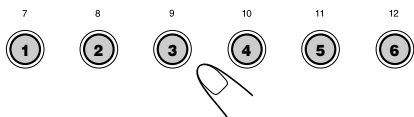

- To select a folder number from 01 – 06:  
Press 1 (7) – 6 (12) briefly.
- To select a folder number from 07 – 12:  
Press and hold 1 (7) – 6 (12) for more than 1 second.

#### Notes:

- If the folder does not contain any MP3 or WMA tracks, playback will not start ("No Music" appears on the display). Select another folder.
- You cannot directly select a folder with a number greater than 12.

To select a particular track in a folder, press ►►| ▲ or ▼ |◄◄ after selecting the folder.

#### On the remote controller:



Press and hold ► (right) while playing a disc to skip to the next folder.

Each time you press and hold the button consecutively, the next folder is located and the first track in the folder starts playing.

Press and hold ◀ (left) while playing a disc to skip back to the previous folder.

Each time you press and hold the button consecutively, the previous folder is located and the first track in the folder starts playing.

#### Note:

If the folder does not contain any MP3 or WMA tracks, it is skipped.



### To skip to the next or previous folder within a folder (on the same hierarchy level)

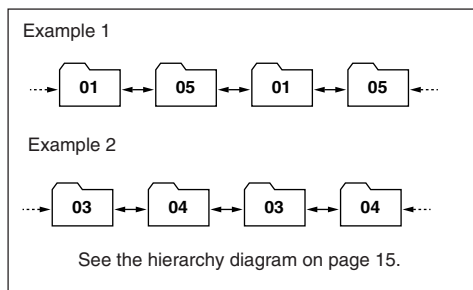

### To skip to the folders on the lower or on the higher hierarchy levels

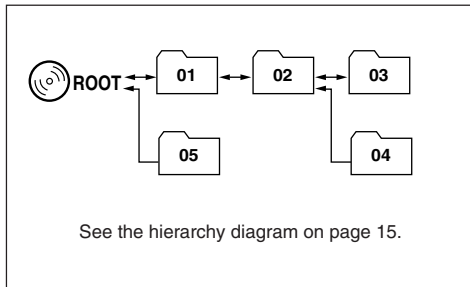

#### **ONLY on the remote controller:**

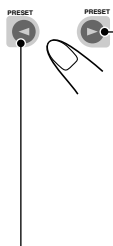

Press ► (right) while playing a disc to skip to the next folder. Each time you press the button consecutively, the next folder included within the same folder (on the same hierarchy level) is located (and the first track in the folder starts playing if recorded).

Press ◀ (left) while playing a disc to skip back to the previous folder.

Each time you press the button consecutively, the previous folder included within the same folder (on the same hierarchy level) is located (and the first track in the folder starts playing if recorded).

**Note:**

If the folder does not contain any MP3 or WMA tracks, playback will not start (“No Music” appears on the display). Select another folder.

#### **ONLY on the remote controller:**

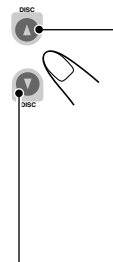

Press ▲ (up) while playing a disc to skip to a folder on the higher hierarchy level. Each time you press the button consecutively, a folder on the higher hierarchy level is located (and the first track in the folder starts playing if recorded).

Press ▼ (down) while playing a disc to skip to a folder on the lower hierarchy level.

Each time you press the button consecutively, a folder on the lower hierarchy level is located (and the first track in the folder starts playing if recorded).

- If there are more than one folder on the lower or higher hierarchy level, a folder with younger playback order number will be located.

**Note:**

If the folder does not contain any MP3 or WMA tracks, playback will not start (“No Music” appears on the display). Select another folder.

To go back to the root directly, press R•D on the remote controller. You can go back to the root from any folder.

- If tracks are recorded on the disc directly without putting them into a folder, this unit starts playing the tracks.



## Selecting a folder and a track using the name lists

The following operations are only possible when playing an MP3 or a WMA disc.

You can show the folder name and track name lists on the display while playing a disc, then select a folder or a track you want to play.

### To select a folder and start playback

- 1 Press and hold ▲ (up) or ▼ (down) so that the folder name list of the inserted disc appears on the display.

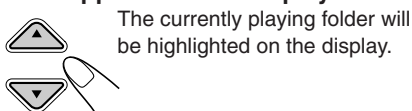

**Notes:**

- The display can show only six names at a time. You can show the other names on the next lists by pressing ▲ (up) or ▼ (down).
- If you press ►► ▲ or ▼ ◄◄, the track name list of the current playing folder appears. Each time you press the button, the folder name list and track name list alternately appears.
- Only folders including MP3 or WMA tracks will be listed.

- 2 Select the number (1 – 6) for the folder you want to play.

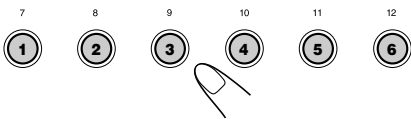

### To select a track and start playback

- 1 Press and hold ▲ (up) or ▼ (down) so that the folder name list of the inserted disc appears on the display.

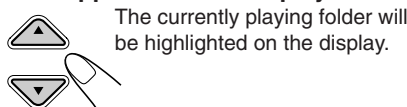

- 2 Show the track name list of the current folder.

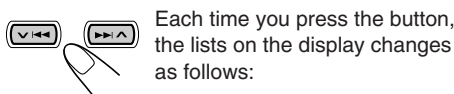

Folder name list ↔ Track name list

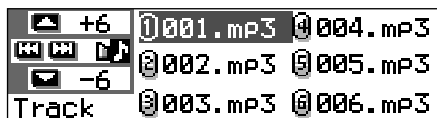

The currently playing track (or folder) will be highlighted on the display.

**Note:**

The display can show only six names at a time. You can show the other names on the next lists by pressing ▲ (up) or ▼ (down).

- 3 Select the number (1 – 6) for the track you want to play.

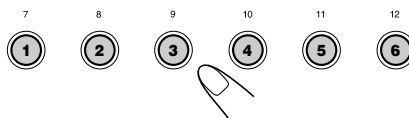



## Selecting playback modes

### To play back tracks at random (Random Play)

You can play back tracks on a disc (or in a folder for MP3 and WMA discs) at random.

- 1 Press MODE (M) while playing a disc.  
“Mode” appears on the display, then the number buttons and the ▲ (up)/▼ (down) buttons start flashing.



While playing an audio CD or a CD Text disc:

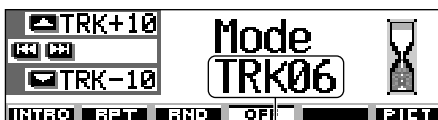

Current track number

While playing an MP3 or a WMA disc:

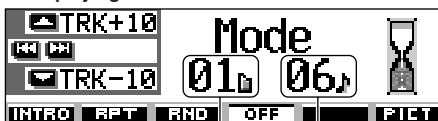

Current folder number

Current track number

- 2 Press number button 3, while “Mode” is still on the display.  
Each time you press the button, random play mode changes as follows:

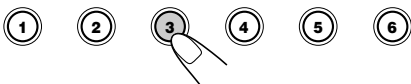

For audio CD and CD Text discs:

Random Disc ↔ Random Off

For MP3 and WMA discs:



Mode	Plays randomly
------	----------------

**Random Folder\***: All tracks of the current folder, then moves to the next folder and so on.

- While playing, lights up on the display.

**Random Disc**: All tracks on the disc.

- While playing, lights up on the display.

\* “Random Folder” can be used for MP3 and WMA discs only.

To cancel Random Play, select “Random Off” by pressing number button 3 repeatedly or press number button 4 in step 2.

### To play back tracks repeatedly (Repeat Play)

You can play back a track (or a folder for MP3 and WMA discs) repeatedly.

- 1 Press MODE (M) while playing a disc.  
“Mode” appears on the display, then the number buttons and the ▲ (up)/▼ (down) buttons start flashing.



- 2 Press number button 2, while “Mode” is still on the display.  
Each time you press the button, repeat play mode changes as follows:





For audio CD and CD Text discs:

Repeat Track ↔ Repeat Off

For MP3 and WMA discs:



For audio CD and CD Text discs:

Intro Track ↔ Intro Off

For MP3 and WMA discs:



Mode	Plays repeatedly
------	------------------

**Repeat Track** : Current (or specified) track.

- While playing, lights up on the display

**Repeat Folder\***: All tracks of the current (or specified) folder.

- While playing, lights up on the display

\* "Repeat Folder" can be used for MP3 and WMA discs only.

To cancel Repeat Play, select "Repeat Off" by pressing number button 2 repeatedly or press number button 4 in step 2.

### To play back only intros (Intro Scan)

You can play back the first 15 seconds of each track sequentially.

1 Press MODE (M) while playing a disc.

"Mode" appears on the display, then the number buttons and the ▲ (up)/▼ (down) buttons start flashing.

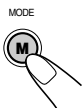

2 Press number button 1, while "Mode" is still on the display.

Each time you press the button, intro scan mode changes as follows:

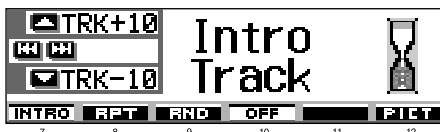

Mode	Plays the beginnings of
------	-------------------------

**Intro Track** : All tracks of the disc.

- While playing, lights up on the display

**Intro Folder\*** : First tracks of all folders.

- While playing, lights up on the display

\* "Intro Folder" can be used for MP3 and WMA discs only.

To cancel Intro Scan, select "Intro Off" by pressing number button 1 repeatedly or press number button 4 in step 2.

### Prohibiting disc ejection

You can prohibit disc ejection and can lock a disc in the loading slot.

While pressing SEL (select), press and hold ▲ for more than 2 seconds.

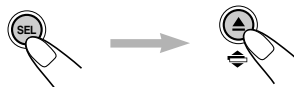

"No Eject" flashes on the display for about 5 seconds, and the disc is locked and cannot be ejected.

To cancel the prohibition and unlock the disc While pressing SEL (select), press and hold ▲ again for more than 2 seconds.

"Eject OK" flashes on the display for about 5 seconds, and the disc is unlocked.



## Changing the display pattern

By pressing DISP (D), you can change the information shown on the display.



Each time you press the button, the display patterns change as follows:

While playing an audio CD or a CD Text disc:

- Initial display



- Disc title/performer or your assigned disc name is emphasized:



- Track title is emphasized:



- Clock time is emphasized:



### Notes:

\*1 If no name is assigned to the audio CD, or if no disc title/performer is recorded for the CD Text, "No Name" will appear.

To assign a name to an audio CD, see page 44.

\*2 "No Name" appears for an audio CD. If no track title is recorded for the CD Text, "No Name" will also appear.

While playing an MP3 or a WMA disc:

- Initial display

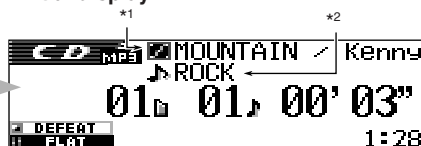

- Album name/performer or folder name is emphasized:



- Track title or track name is emphasized:



- Clock time is emphasized:



### Notes:

\*1 If "Tag" is set to "Off" (see page 41), folder name appear with

\*2 If "Tag" is set to "Off" (see page 41), track name appear with

### Display indication:

- When the title is emphasized at the center of the display, it is shown entirely by scrolling if it cannot be shown at a time. See also "To select the scroll mode—Scroll" on page 41.
- Some characters or symbols will not be shown (will be blanked or substituted) on the display.





## Selecting the DSP modes

Using the DSP (Digital Signal Processor) modes built in this unit, you can create a more acoustic sound field in your car compartment.

### Available DSP modes:

- THEATER:** Reminds you of the intensity reproducing a theater.
- HALL:** Reminds you of a large concert hall with a being-there feeling.
- CLUB:** Reminds you of powerfulness reproduced in a dance club.
- DOMESTIC:** Reminds you of a dome with a high ceiling.
- STUDIO:** Reminds you of live sounds in a recording studio.
- V. CANCEL:** Reduces the vocal sounds (Voice Cancel). Good for mastering your favorite songs—Karaoke.
- DEFEAT:** Cancels the DSP modes.

### Note:

Effectiveness of “V.CANCEL” depends on the recording condition of the sources. Especially, if you play back the following sources you cannot get the satisfactory results.

- Monaural sources such as AM and monaural FM broadcasting programs,
- Multiplex sound sources, and
- Sources recorded with duets, strong echo, a chorus, or only a few instruments.

## 1 Press SEL (select) once to show the DSP mode selection screen.



The last selected DSP mode screen appears.



- If you press the button twice or more, the unit enters different sound adjustment modes.



- For iEQ (sound mode) settings, see pages 28 and 29.
- For SEL (basic sound) settings, see pages 30 and 31.

## 2 Press the number button to select one of the DSP modes listed on the display.

- This unit has two DSP mode selection screens. To move to the other screen, press ▲ (up) or ▼ (down).

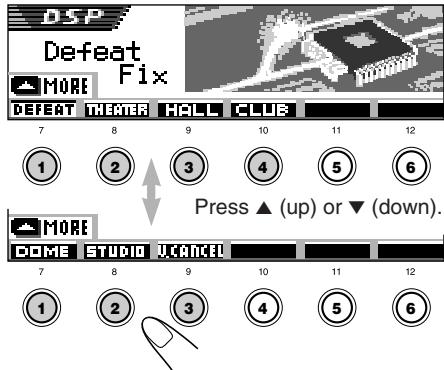

CONTINUED ON THE NEXT PAGE



### 3 Adjust the DSP effect level—1, 2, or 3.

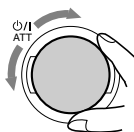

The selected DSP effect level is valid for all DSP modes except "V.CANCEL."

- As the number increases, the effect level becomes stronger.



Ex. When "Dome" is selected in the previous step

To cancel the DSP modes, select "DEFEAT" in step 2.

To exit from the DSP mode selection screen, press SEL (select) repeatedly or wait for about 15 seconds.

### To make further precise settings for the DSP modes

You can also make further precise settings to make the best sound field in your car compartment. These settings you make are valid for all DSP modes except "V.CANCEL."

#### Setting items:

##### The number of the built-in speakers :

Select the number of the speakers built in your car—"2ch" or "4ch."

- When you have four speakers (4ch) built in your car, select your car size (see step 5 on page 27).

##### Listening seat position:

Select the listening seat position where you want to locate the sound image.

### 1 Press SEL (select) once to show the DSP mode selection screen.



The currently activated DSP mode appears on the display.



Ex. When "Dome" is selected previously

- If the DSP mode is not activated ("DEFEAT" is selected), you cannot go to the next step. Select one of the DSP modes first.



**2** Press number button 6 to enter the further precise setting screen.

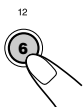

**5** If you select “4ch,” rotate the control dial to select your car size.

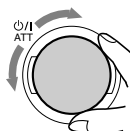

As you rotate it, the car size changes as follows:

**Compact** ↔ **Middle** ↔ **Large**

**3** Select your listening seats position.

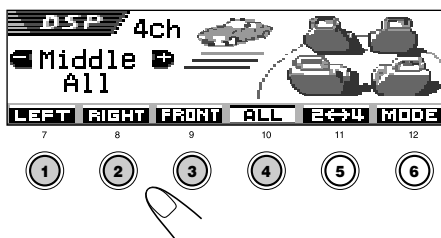

- Press **number button 1** to select “LEFT (front left)” seat.
- Press **number button 2** to select “RIGHT (front right)” seat.
- Press **number button 3** to select “FRONT” seats.
- Press **number button 4** to select “ALL” seats.

**Note:**

If fader or balance has been set close to its extreme, appropriate effect may not be obtained.

**4** Press number button 5 to set the number of the built-in speakers.



- Select “4ch” for the four speaker system, and “2ch” for the two speaker system.

**Note:**

When “4ch” is selected, rear speakers are used only to reproduce reflections and reverberations in order to create a being-there feeling in your car compartment.

- **Compact:** Select when the distance from the rear speakers to the listening seat position is shorter than that from the front speakers.
- **Middle:** Select when the distance from the rear speakers to the listening seat position is almost equal to that from the front speakers.
- **Large:** Select when the distance from the rear speakers to the listening seat position is longer than that from the front speakers.

**Note:**

If you have selected “2ch” in the previous step, you cannot select the car size.

To go back to the DSP mode selection screen, press number button 6.

To exit from the DSP mode selection screen, press SEL (select) repeatedly or wait for about 15 seconds.



# EQUALIZER OPERATIONS

## Selecting preset sound modes (iEQ: intelligent equalizer)

You can select a preset sound mode (iEQ: intelligent equalizer) suitable to the music genre.

### Available sound modes:

- H. ROCK (Hard Rock)
- R & B (Rhythm and Blues)
- POP (Popular music)
- JAZZ (Jazz)
- DANCE (Dance music)
- Country (Country music)
- REGGAE (Reggae)
- CLASSIC (Classical music)
- USER 1, USER 2, USER 3
- FLAT (No sound mode is applied)

## 2 Press the number button to select one of the sound modes listed on the display.

- This unit has two sound mode selection screens. To move to the other screen, press ▲ (up) or ▼ (down).

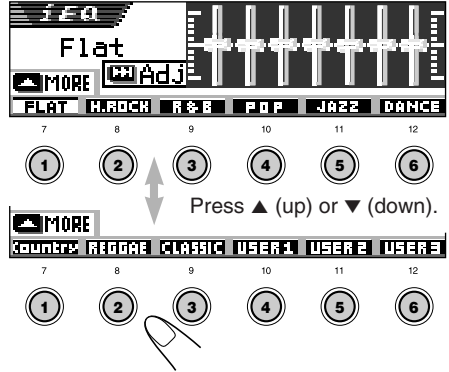

## 1 Press SEL (select) twice to show the sound selection screen.



The last selected sound mode is called up.

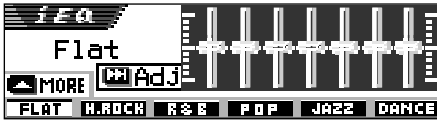

- If you press the button more than twice, the unit enters different sound adjustment modes.



- For DSP mode settings, see pages 25 to 27.
- For SEL (basic sound) settings, see pages 30 and 31.

To cancel the sound mode, select "FLAT" in step 2.

To exit from the sound mode selection screen, press SEL (select) repeatedly or wait for about 15 seconds.

### Notes:

- For details about the preset settings of each sound mode, see page 55.
- If "V.CANCEL" is selected for the DSP mode, you cannot change the sound modes.



## Storing your own sound modes

You can adjust the sound modes to your preference and store your own adjustments in memory (USER 1, USER 2 and USER 3).

- 1** Press SEL (select) twice to show the sound mode selection screen.



The last selected sound mode is called up.

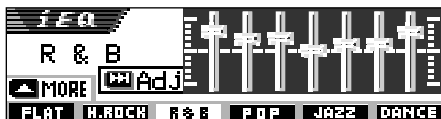

Ex. When "R & B" is selected previously

- 2** Press the number button to select one of the sound modes listed on the display.

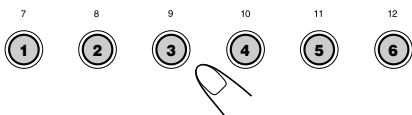

- This unit has two sound mode selection screens. To move to the other screen, press ▲ (up) or ▼ (down).

- 3** Enter the sound adjustment mode.

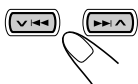

The following sound mode adjustment screen appears on the display.

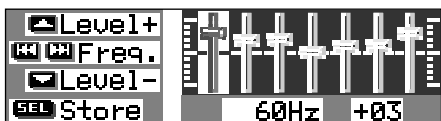

- 4** Make adjustments as you like.

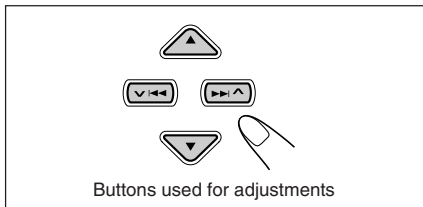

- Press ►► ▲ or ▼ ◀◀ to select the frequency band—60Hz, 150Hz, 400Hz, 1kHz, 2.4kHz, 6kHz, 12kHz.
- Press ▲ (up) or ▼ (down) to adjust the level of the selected band within the range of -05 to +05.
- Repeat steps 1) and 2) to adjust the other frequency bands.

- 5** Store the adjustment you made.



The confirmation message appears—whether you want to store the adjustment.

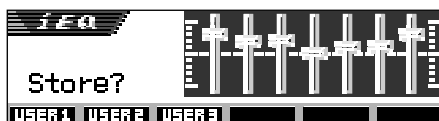

If you want to cancel the adjustment, press DISP (D).

- Adjustment you made remains effective until you select another sound mode.

- 6** Press number button 1, 2 or 3 to select one of the user sound modes (USER 1, USER 2, or USER 3) you want to store into.

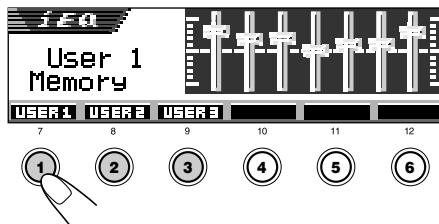

Ex. When you select "USER 1."



# SOUND ADJUSTMENTS

ENGLISH

## Performing the basic sound settings

You can set the speaker output balance, subwoofer output level, and input level of each source.

- There is a time limit in doing the following procedure. If the setting is canceled before you finish, start from step 1 again.

### 1 Press SEL (select) repeatedly to show one of the basic sound setting (SEL) screens.



Each time you press the button, the adjustable items change as follows:

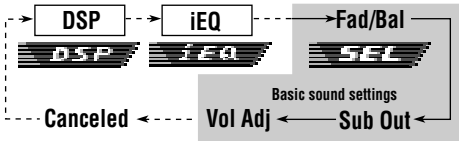

- For DSP mode settings, see pages 25 to 27.
- For iEQ (sound mode) settings, see pages 28 and 29.

Indication	To do:	Range
Fad	Adjust the front and rear speaker balance.	R06 (Rear only)   F06 (Front only)
Bal	Adjust the left and right speaker balance.	L06 (Left only)   R06 (Right only)
Sub Out	Adjust the subwoofer output level and cutoff frequency level.	00 (min.)   08 (max.) Low/Mid/High
Vol Adj	Adjust and store the input level of each source.	-05 (min.)   +05 (max.)

### 2 Adjust the level.

**To adjust fader and balance—Fad, Bal:** Make these two adjustments at the same time.

- If you are using a two-speaker system, set the fader level to “00.”

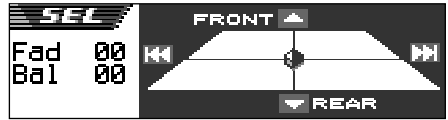
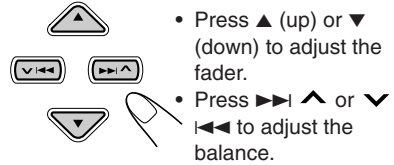

**To adjust subwoofer output—Sub Out:** This takes effect only when a subwoofer is connected.

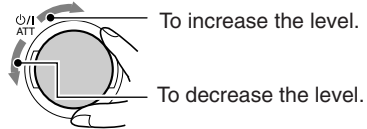

You can also set an appropriate cutoff frequency level according to the subwoofer connected.

- Press ►► ▲ or ▼ ◀◀ to select “Low,” “Mid,” or “High.”
- Low: Frequencies higher than 50 Hz are cut off to the subwoofer.
- Mid: Frequencies higher than 80 Hz are cut off to the subwoofer.
- High: Frequencies higher than 115 Hz are cut off to the subwoofer.



### To adjust the input level of each source —Vol Adj:

This setting is required for each source except FM. Before making an adjustment, select an appropriate source for which you want to make an adjustment.

Once you have made an adjustment, it is memorized, and you will not need to adjust the volume level each time you change the source.

Adjust to match the input level to the FM sound level.

- You cannot make an adjustment if the source is FM. "FIX" will appear.

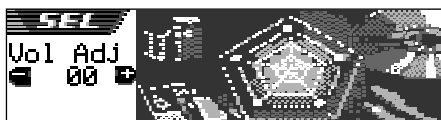
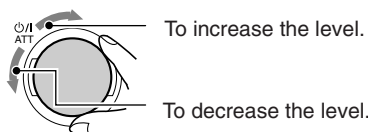

## Making sounds natural —BBE Digital

BBE Digital\* is a new digital processing method to restore the brilliance and clarity of the original live sound in recording, broadcasts, etc. When a speaker reproduces sound, it introduces frequency-dependent phase shifting, causing high-frequency sounds to take longer to reach the ear than low frequency sounds. BBE Digital adjusts the phase relationship between the low, mid and high frequencies by adding a progressively longer delay time to the low and mid frequencies, so that all frequencies reach the listener's ears at the proper time.

### 1 Show the BBE Digital adjustment screen.



The current BBE level is shown on the display.



### If the **INPUT OVER** (INPUT OVER) indicator appears on the display, and sounds are distorted

The input level through the external component (LINE IN) is set at a high level (more than 1.5 Vrms).

If this happens, adjust the output level on the connected component so that the **INPUT OVER** (INPUT OVER) indicator will not appear.



**INPUT OVER** (INPUT OVER) indicator

### 2 Select the effect level.



Each time you press the button, the effect level changes as follows:

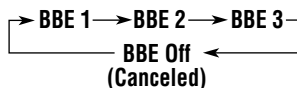

As the number gets higher, the effect level becomes stronger.

When shipped from the factory, the effect level is set to "BBE Off" (BBE Digital is canceled).

#### Note:

If "V.CANCEL" is selected for the DSP mode, you cannot change the BBE level.

\* Manufactured under license from BBE Sound, Inc.

Licensed by BBE Sound, Inc. under USP4638258 and 4482866. BBE and BBE symbol are registered trademarks of BBE Sound, Inc.

With Image Converter included in the supplied CD-ROM, you can edit your own favorite pictures and use them as your own opening screen, ending screen, and graphic screen while playing a source.



## What is Image Converter

Image Converter is a JVC's original software to produce a custom image to show on your JVC Car Audio.

## Here is a basic procedure to make a CD-R including still images (pictures) and animations (movies) with Image Converter

In this manual, we only explain how to export the files (still images and animations) into the memory built in this unit—step 5 below.

- For the other processes (from steps 1 to 4 below), refer to Image Converter manual or PDF files included in the "Manual" folder of the supplied CD-ROM.

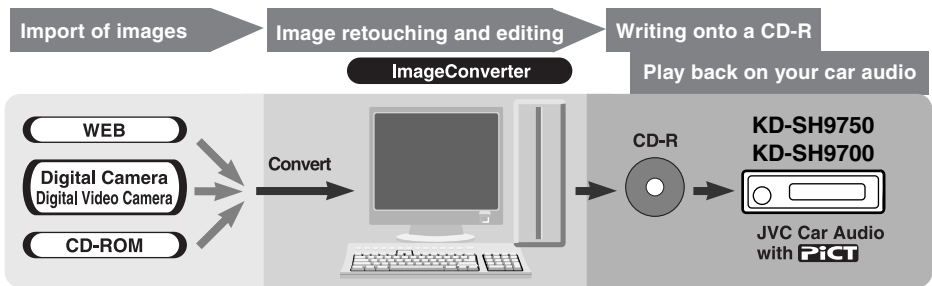

## 1 Install / Start the program

Install Image Converter on your PC.

## 2 Import the images

Import the source images from the Image Converter CD-ROM or from other equipment like a digital camera or a digital video camera.

## 3 Retouch and edit the images

Retouch the images like trimming or adjusting the color, editing the animation effect, and adding the texts.

## 4 Write your images onto a CD-R

Write the animations or the still images you made with Image Converter using your CD-R writing software.

You have to write the images you made onto a CD-R to enjoy the images on your Car Audio.

- To write data onto a CD-R, refer also to the instruction of your CD-R writing software.

## 5 Enjoy the animations or the still images you made on your Car Audio

Export the images to your JVC Car Audio from the CD-R you made.



# Downloading images and animations

Before starting the following procedure, prepare a CD-ROM including still images (pictures) and animations (movies).

- The supplied Image Converter CD-ROM includes sample images and animations, so you can use this disc as your first trial.

**IMPORTANT:**

- Still images (pictures) should have <jml>, and animations (movies) should have <jma> as their extension code in their file names.
- Downloading a file can be done only while selecting "CD" as the source; on the other hand, deleting a file can be done while selecting any source.
- Before you download or erase the files, observe the following:
  - Do not download a file while driving.
  - Do not turn off the ignition key of the car while downloading or erasing a file.\*
  - Do not detach the control panel while downloading or erasing a file.\*
- \* If you do it, the file download or erasure will not be done correctly. In this case, perform the same procedure again.
- If you have already downloaded an animation for "PowerOn," "PowerOff," or "Movie," downloading a new animation deletes the previously stored animation.
- It takes a long time for the unit to download an animation.
  - About 6 to 7 seconds for a still image (one frame).
  - About 3 to 4 minutes for an animation of 30 frames.
  - About 10 minutes for an animation of 90 frames.

## 1 Open the control panel.

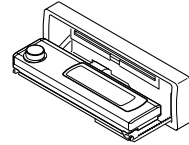

## 2 Insert a CD-ROM with the files (images and animations) into the loading slot.

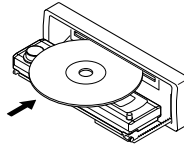

The unit draws the disc, the control panel goes back to the previous position (see page 45)

- If the disc includes playable audio files such as MP3 tracks, playback starts automatically.

## 3 Press MODE (M) after the disc is detected.



"Mode" appears on the display, then the number buttons and the ▲ (up)/▼ (down) buttons start flashing.

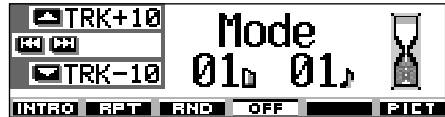

## 4 Press number button 6 to show the download selection screen.



CONTINUED ON THE NEXT PAGE

**5 Select (highlight) one of the listed items for which you want to download a file.**

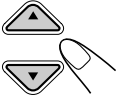

- **PowerOn** : Opening screen  
To download an animation to be shown after the unit is turned on. (You can store only one animation consisting of 30 frames maximum.)
- **PowerOff** : Ending screen  
To download an animation to be shown before the unit is turned off. (You can store only one animation consisting of 30 frames maximum.)
- **Picture** : Graphic screen\*  
To download a still image to be shown while playing a source. (You can store 90 still images—each one frame.)
- **Movie** : Graphic screen\*  
To download an animation to be shown while playing a source. (You can store only one animation consisting of 90 frames maximum.)

\* Graphic screen will appear only if no operation is done for about 20 seconds.

If you want to cancel the procedure, press number button 5, the download selection screen goes off.

**6 Show the name list of the folder included in the inserted CD-R.**

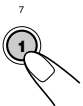

"File Check...." appears for a while, then the folder list appears.

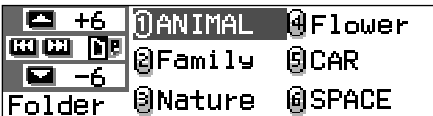

The currently selected folder will be highlighted on the display.

**Notes:**

- On this list, the folders including the target files—<jml> files for "Picture" and <jma> files for the others—are shown.
- The display can show only six names at a time. You can show the other names on the next lists by pressing ▲ (up) or ▼ (down).
- If a disc inserted does not include any <jml> and <jma> files, beeps sound and you cannot go to the next step.

**7 Select (highlight) a folder in which a file you want is included.**

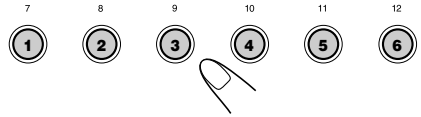

**8 Show the name list of the files included in the selected folder.**

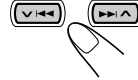

Each time you press the button, the lists on the display changes as follows:

**F** Folder name list ↔ **F** File name list

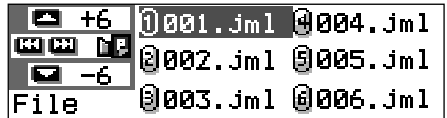

Ex. When you have selected "Picture" in step 5.

**Note:**

The display can show only six names at a time. You can show the other names on the next lists by pressing ▲ (up) or ▼ (down).

## 9 Select a file you want to download.

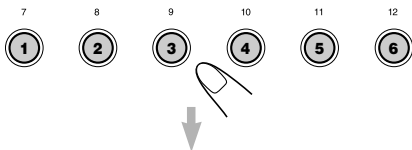

The file name appears, and the unit will ask you "Download OK?"

## 10 If it is OK, press number button 1 to start downloading.

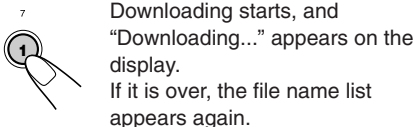

If it is not OK, press number button 5, the file selection screen appears again. Repeat from step 8 again.

## 11 Repeat steps 8 to 10 if you are downloading files for "Picture" and want to store more files.

## 12 Finish the download procedure.



To download a file for another item listed on the download selection screen, repeat from step 3 again.

### Notes:

- If you try to store the 91st image for picture screen, "Picture Full" appears and you cannot start downloading. In this case, delete unwanted files before downloading.
- If the total frame number of an animation downloaded exceeds the following number, the frames exceeding that numbers are ignored.
  - For opening and ending screens: 30
  - For movie screen: 90

## Deleting unwanted files

- When "BACK" is shown on the display above number button 5, you can go back to the previous screen by pressing number button 5.

### To delete all the stored files at a time

- 1 Press MODE (M) while playing any source. "Mode" appears on the display, and the number buttons and ▲ (up)/ ▼ (down) buttons start flashing. 

- 2 Press number button 6 to show the download selection screen. 



- 3 Press ▲ (up) or ▼ (down) to select (highlight) all the listed items. 



- 4 Press number button 4. The unit asks you "All File Delete OK?" 

- 5 Press number button 4 again. "Now Deleting..." appears while erasing the files. When erasure is over, the download selection screen appears again. 

- 6 Press number button 5 to resume the source indication screen. 

### To delete the files stored for “PowerOn,” “PowerOff,” “Picture (all stored images at a time),” and “Movie”

1 Press MODE (M) while playing any source.  
“Mode” appears on the display, and the number buttons and ▲ (up)/ ▼ (down) buttons start flashing.



2 Press number button 6 to show the download selection screen.



3 Press ▲ (up) or ▼ (down) to select (highlight) one of the listed items.

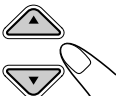

Ex. When selecting “Picture”



Appears when “Picture” is selected (highlighted)

4 To delete the file stored in “PowerOn,” “PowerOff,” and “Movie,” press number button 3.  
The file name of the previously stored animation appears, and the unit asks you “Delete OK?”



To delete all the files stored in “Picture” at a time, press number button 4.  
The unit asks you “All Picture Delete OK?”

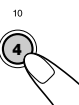

5 To delete the file stored in “PowerOn,” “PowerOff,” and “Movie,” press number button 3 again.



To delete all the files stored in “Picture” at a time, press number button 4 again.



“Now Deleting...” appears while erasing the selected file. When erasure is over, the download selection screen appears again.

6 Press number button 5 to resume the source indication screen.



### To delete the stored files for “Picture” (one by one)

1 Press MODE (M) while playing any source.  
“Mode” appears on the display, and the number buttons and ▲ (up)/ ▼ (down) buttons start flashing.



2 Press number button 6 to show the download selection screen.



3 Press ▲ (up) or ▼ (down) to select (highlight) “Picture.”

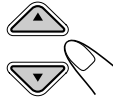

4 Press number button 3.  
The unit shows the name list of the stored files.

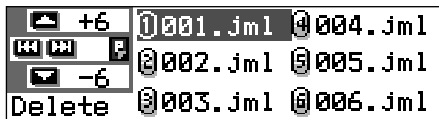

**Note:**

The display can show only six names at a time. You can show the other names by pressing ▲ (up) or ▼ (down) repeatedly.

5 Press the number buttons for the file you want to delete.

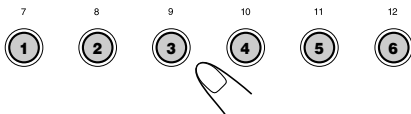

Selected file name appears, and the unit asks you “Delete OK?”

6 Press number button 3 to start erasure.  
“Now Deleting...” appears while erasing the selected file. When erasure is over, the name list of the stored file appears again.



- 7 To delete more files, repeat from steps 5 and 6.
- 8 Press DISP (D) to resume the source indication screen.



- 3 Select “Opening” (opening screen setting) or “Ending” (ending screen setting).



Ex. When you select “Opening”

- 4 Select “User.”



- Default: Factory-preset animation is used.
- User: Your own edited animation is used.

- 5 Finish the setting.



### To activate the graphic screen using either picture or movie

Using this setting, you can change the graphic displays. These graphic screen appears if no operation is done for about 20 seconds.

- If no image is stored in “Picture,” or no animation in “Movie,” “UserPict.” will not be selected as a PSM item.

- 1 Press and hold SEL (select) for more than 2 seconds so that one of the PSM items appears on the display. (PSM: see page 40.)



## Activating the downloaded images and animations

### To activate the animations stored for opening and ending screens

After the unit turns on or before the unit turns off, you can see preset animations on the display. These are called opening screen and ending screen. You can use your own edited animations for these opening and ending screens.

- If no animation is stored in “PowerOn” and “PowerOff,” “Opening” and “Ending” will not be selected as a PSM item.

- 1 Press and hold SEL (select) for more than 2 seconds so that one of the PSM items appears on the display. (PSM: see page 40.)



- 2 Press number button 1 to select—“MOVIE”—Movie category of the PSM settings.

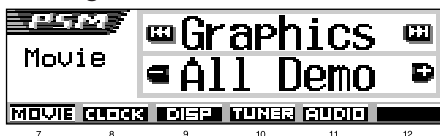

The “Graphics” setting screen appears on the display.

CONTINUED ON THE NEXT PAGE

**2** Press number button 1 to select—  
“MOVIE”—Movie category of the PSM  
settings.



The “Graphics” setting screen appears on the display.

**3** Select “UserMovie,” “UserSlide,” or  
“UserPict.”



Ex. When you select “UserPict.”

- UserMovie: Your edited animation stored in “Movie” is activated as your graphic screen.
- UserSlide: Your edited still images stored in “Picture” are activated and shown in sequence as your graphic screen.
- UserPict.: One of your edited still image stored in “Picture” is activated as your graphic screen. Select one of the stored images (see the next column).

**4** Finish the setting.



To cancel all graphic displays, select “Off” in step 3.

**Note:**

For the “Graphics” setting, you can also select “All Demo,” “Int Demo,” and “ImageLink.”

— See pages 8 and 41 for “All Demo” and “Int Demo.”

— See pages 17 and 41 for “ImageLink.”

**To select a still image for graphic display—User Picture**

You cannot select “UserPict.” as a PSM item in the following cases:

- If no image is stored in “Picture,” or
- “UserPict.” is not selected for the “Graphics” setting (see the left column).

**1** Press and hold SEL (select) for more than 2 seconds so that one of the PSM items appears on the display. (PSM: see page 40.)



**2** Press number button 1 to select—  
“MOVIE”—Movie category of the PSM  
settings.



The “Graphics” setting screen appears on the display.

**3** Select “UserPict.”



File name of the currently selected image also appears.

**4** Select a file you want.

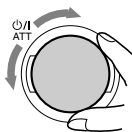

**5** Finish the setting.





## Changing the general settings (PSM)

You can change the items listed on the table on the next page by using the PSM (Preferred Setting Mode) control.

- The PSM items are grouped into five categories—MOVIE, CLOCK, DISP (display), TUNER, and AUDIO.

### Basic Procedure

Ex. To change “Contrast”

- Press and hold SEL (select) for more than 2 seconds so that one of the PSM items appears on the display. (See page 40.)



The number buttons,  $\nabla$   $\lll$  /  $\ggg$   $\blacktriangle$ , and control dial start flashing to teach you that they can be used for the next operational steps.

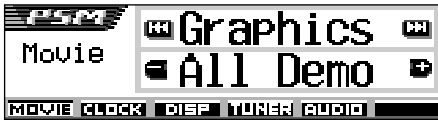

Ex. When you have selected “Graphics” previously

- Press number button (in this example, 3) to select one of the PSM categories.

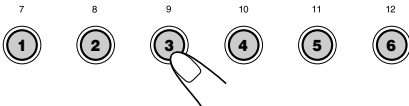

The first-listed item in the selected category appears.

- Select the PSM item you want to adjust.

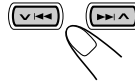

- By pressing  $\ggg$   $\blacktriangle$  or  $\nabla$   $\lll$  repeatedly, you can also move to another category.

- Adjust the PSM item selected.

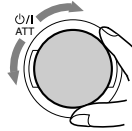

- Repeat steps 2 to 4 to adjust the other PSM items if necessary.

- Finish the setting.





Preferred Setting Mode (PSM) items

Indications		Selectable values	Initial settings	Page	
MOVIE	<b>Graphics</b> Movie demonstration	See page 41.		All Demo	41
	<b>KeyIn CFM</b> Key-in confirmation	Long    ↔    Short ↕    Off    ↕	Long		41
	<b>Opening</b> <sup>*1</sup> Opening animation	Default	User	Default	37
	<b>Ending</b> <sup>*1</sup> Ending animation	Default	User	Default	37
	<b>UserPict</b> <sup>*2</sup> User Picture	From the stored files		First stored	38
CLOCK	<b>Clock Hr</b> Hour adjustment	Back	Advance	1 (1:00AM)	8
	<b>Clock Min</b> Minute adjustment	Back	Advance	00 (1:00AM)	8
	<b>24H/12H</b> 24 hours or 12 hours	12Hours	24Hours	12Hours	8,9
DISP (display)	<b>Scroll</b> Scroll mode	Once    ↔    Auto ↕    Off    ↕	Once		41
	<b>Dimmer</b> Dimmer mode	↔ Auto ↔ Off ↔ ↕ Time Set ↔ On ↕	Auto		43
	<b>From– To</b> <sup>*3</sup> Dimmer time setting	Any time – Any time		6PM – 7AM	43
	<b>Contrast</b> Contrast	1 – 10		5	41
	<b>LCD Type</b> Display type	Auto    ↔    Positive ↕    Negative    ↕	Auto		41
	<b>Font Type</b> Font type	1	2	1	41
	<b>Tag</b> Tag display	Off	On	On	41
	<b>Theme</b> Theme—Level meter	↔ Standard ↔ Meter 1 ↔ ↕ Meter 3 ↔ Meter 2 ↕	Standard		9
TUNER	<b>IF Filter</b> Intermediate frequency filter	Wide	Auto	Auto	42
	<b>Area</b> Tuner interval	US	Europe	US	42
AUDIO	<b>Beep</b> Key-touch tone	Off	On	On	42
	<b>Ext Input</b> <sup>*4</sup> External component	Changer	Line In	Changer	42
	<b>Line In</b> <sup>*5</sup> Line Input switch	Off	On	On	42
	<b>PowerAmp</b> Power amplifier switch	Off	On	On	42

\*1 Displayed only after a downloadable file is stored in memory.

\*2 Displayed only after a downloadable file is stored in memory and while selecting “UserPict.” for “Graphics.”

\*3 Displayed only when “Dimmer” is set to “Time Set.”

\*4 Only for KD-SH9700: Not displayed when the current source is “CD-CH (CD changer)” or “LINE IN.”

\*5 Only for KD-SH9750: Not displayed when the current source is “LINE IN.”





## To show the graphics on the display— Graphics

You can change the graphics shown on the display. These graphics appear if no operation is done for about 20 seconds (except for “ImageLink”).

- All Demo: Display demonstration (animation) appears (see page 8).
- Int Demo: Display demonstration (animation) and playback source indication appears alternately (see page 8).
- UserMovie: Your edited animation appears (see pages 37 and 38).
- UserSlide: Your edited still images appears in sequence (see pages 37 and 38).
- UserPict.: One of your edited still image appears (see pages 37 and 38).
- ImageLink: To show a still image while playing back an MP3/WMA tracks (see page 17).
- Off: Cancels all graphic display above.

### Note:

You can select “UserMovie,” “UserSlide,” and “UserPict.” only after downloading the appropriate files in memory. (See page 33.)

## To select the source animation on the display—KeyIn CFM

When changing the source, the display shows the source animation. You can select the source animation on the display according to your preference.

- Long: A long source animation appears.
- Short: A short source animation appears.
- Off: Cancels the source animation.

## To select the scroll mode—Scroll

When a disc information is emphasized at the center of the display, it is shown entirely by scrolling if it cannot be shown at a time.

- Once: Scrolls only once.
- Auto: Repeats the scroll (in 5-second intervals).
- Off: Cancels scroll mode.

### Note:

Even if the scroll mode is set to “Off,” you can scroll the display by pressing DISP (D) for more than 1 second.

## To adjust the display contrast level —Contrast

You can adjust the display contrast level among 1 to 10.

Adjust it to make the display indications clear and legible.

## To select the display illumination pattern —LCD Type

You can select the display illumination patterns according to your preference.

- Auto: Positive pattern will be selected during the day time (depending on the “Dimmer” setting); on the other hand, negative pattern will be used during the night time (depending on the “Dimmer” setting).
- Positive: Positive (normal) pattern of the display.
- Negative: Negative pattern of the display.

## To select the font on the display —Font Type

You can change the font types used on the display. Select either “1” or “2” according to your preference.

## To turn the tag display on or off—Tag

An MP3 and WMA track can contain track information called “Tag” where its album name, performer, track title, etc. are recorded.

- On: Turns on the Tag display while playing MP3 or WMA tracks.
  - If a track does not have Tags, folder name and track name appear.
- Off: Turns off the Tag display while playing MP3 or WMA tracks. (Only the folder name and track name appear.)

**Notes:**

- If you change the setting from “Off” to “On” while playing a track, the tag display will be activated when the next track starts playing.
- For MP3 tracks only: There are two versions—ID3v1 (ID3 Tag version 1) and ID3v2 (ID3 Tag version 2). When both ID3v1 and ID3v2 are recorded, ID3v2 will be shown.

**To change the FM tuner selectivity  
—IF Filter**

In some areas, adjacent stations may interfere with each other. If this interference occurs, noise may be heard.

- Auto: When this type of interference occurs, this unit automatically increases the tuner selectivity so that interference noise will be reduced. (But the stereo effect will also be lost.)
- Wide: Subject to the interference from adjacent stations, but sound quality will not be degraded and the stereo effect will not be lost.

**To change the AM/FM channel intervals  
—Area**

When this unit is shipped from the factory, the channel intervals are set to 10 kHz for AM and 200 kHz for FM (US settings).

You will have to change the channel intervals when using this unit in an area other than North America and South America.

- US: Select when using this unit in North or South America. (10 kHz for AM and 200 kHz for FM)
- Europe: Select when using this unit in an area other than North and South America. (9 kHz for AM and 50 kHz (for manual tuning) / 100 kHz (for searching) for FM)

**Note:**

If the channel intervals settings are changed, the names assigned to the stations will be erased from memory. To reassign the names, see “Assigning names to the sources” on page 44.

**To turn on/off the key-touch tone—Beep**

You can deactivate the key-touch tone if you do not want it to beep each time you press a button.

- On: Activates the key-touch tone.
- Off: Deactivates the key-touch tone.

**To select the external component to use  
—Ext Input (Only for KD-SH9700)**

You can connect the external component to the CD changer jack on the rear using the Line Input Adapter KS-U57 (not supplied).

To use the external component as the playback source through this unit, you need to select which component—CD changer or external component—to use.

- Changer: To use the CD changer.
- Line In: To use the external component other than CD changer.

**Note:**

For connecting the Line Input Adapter KS-U57 and the external component, refer to the Installation/Connection Manual (separate volume).

**To turn on/off the line input switch  
—Line In (Only for KD-SH9750)**

You can switch off the line input when no external component is connected to the LINE IN plugs.

- On: You can select “LINE IN” as the playback source.
- Off: You cannot select “LINE IN” as the playback source.

**To turn on/off the power amplifier switch—  
PowerAmp**

You can switch off the built-in amplifier and send the audio signals only to the external amplifier(s) to get clear sounds and to prevent internal heat buildup inside this unit.

- On: When not using external amplifier(s).
- Off: When using external amplifier(s).



# Selecting the dimmer mode

You can dim the display at night automatically or as you set the timer. When shipped from the factory, Auto Dimmer mode is activated.

**Note:**  
Auto Dimmer equipped with this unit may not work correctly on some vehicles, particularly on those having a control dial for dimming.  
In this case, select any other than "Auto."

**1** Press and hold SEL (select) for more than 2 seconds so that one of the PSM items appears on the display. (See page 40.)



**2** Press number button 3 to select "DISP"—Display category of the PSM settings.

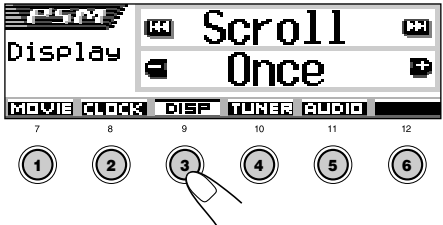

**3** Press >>> ^ or v <<< to select "Dimmer."

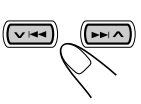

**4** Set the dimmer mode as you like.

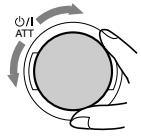

- Auto: Activates Auto Dimmer. When you turn on the car head lights, the display automatically dims.
- Off: Cancels Auto Dimmer.
- On: Always dims the display.
- Time Set: Used to set the timer for the dimmer mode.

**Note:**  
Selecting "Auto" or "Time Set" may change the display pattern to the "Negative" or "Positive" pattern if "LCD Type" is set to "Auto."

- If you select "Time Set," go to the following steps to set the timer.
- If you select any other than "Time Set," go to step 7 to finish the setting.

**5** Select "From-To" to set the timer for the dimmer mode.

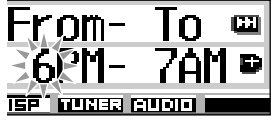
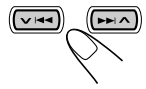

**6** Set the timer.

- 1 Turn the control dial to select the start time.
- 2 Press >>> ^ once.
- 3 Turn the control dial to select the end time.

**7** Finish the setting.





# Assigning names to the sources

You can assign names to station frequencies, CDs (both in this unit and in the CD changer), and the external component. After assigning a name, it will appear on the display when you select the source.

Sources	Maximum number of characters
Station frequencies	Up to 10 characters (up to 30 station frequencies including both FM and AM)
CDs*	Up to 32 characters (up to 40 discs)
External component	Up to 8 characters

\* You cannot assign a name to CD Text, MP3, and WMA discs.

## 1 Select a source you want to assign a name to.

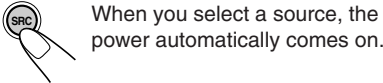

## 2 While holding DISP (D), press and hold SEL (select) for more than 2 seconds.

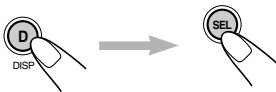

Ex.: When you select an FM station as the source

## 3 Select the character set you want while the first character position is flashing.



Each time you press the button, the character set changes as follows:

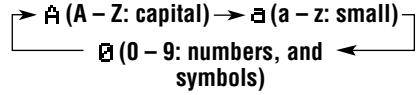

## 4 Select a character.

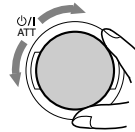

• About the available characters, see page 55.

## 5 Move the cursor to the next (or previous) character position.

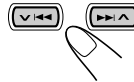

## 6 Repeat steps 3 to 5 until you finish entering the name.

## 7 Finish the procedure while the last selected character is flashing.



### To erase the entered characters

Insert spaces using the same procedure described above.

### Notes:

- When you try to assign a name to the 41st disc or to the 31st station frequency, "Name Full" appears and you cannot enter the text entry mode. In this case, delete unwanted names before assignment.
- When the CD changer is connected, you can assign names to CDs in the CD changer. These names can also be shown on the display if you insert the CDs in this unit.



# Changing the control panel angle

You can change the angle of the control panel to four positions.

**1** Press and hold ▲ (⇄) until the angle adjustment screen appears.



The ▲ (up) and ▼ (down) buttons start flashing to teach you that they can be used for the next operational steps.



**2** Adjust the angle to the position you want.

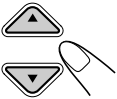

The control panel angles changes as follows:

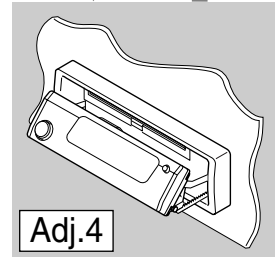
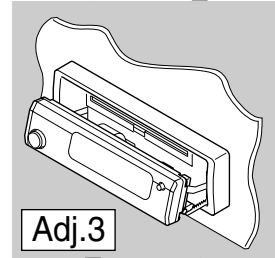
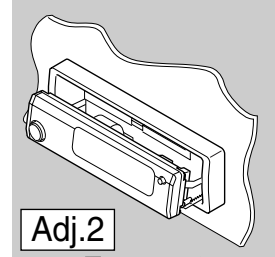
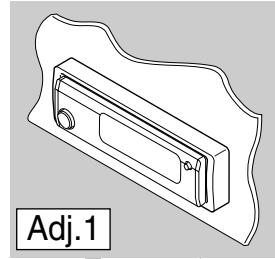

**CAUTION:**

NEVER insert your finger in between the control panel and the unit, as it may get caught or hurt.

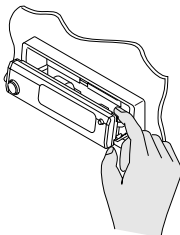

**When using the remote controller**

You can change the angle position simply by pressing ANGLE ▲ or ANGLE ▼.



## Detaching the control panel

You can detach the control panel when leaving the car.

When detaching or attaching the control panel, be careful not to damage the connectors on the back of the control panel and on the panel holder.

### Detaching the control panel

Before detaching the control panel, be sure to turn off the power.

#### 1 Unlock the control panel.

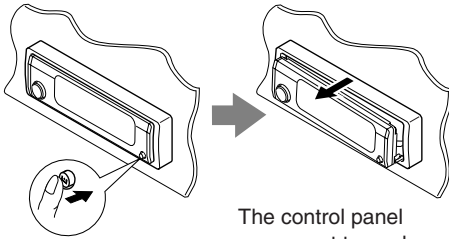

The control panel comes out toward you.

#### 2 Move the control panel to the right, then pull it out of the unit.

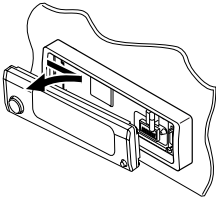

#### 3 Put the detached control panel into the provided case.

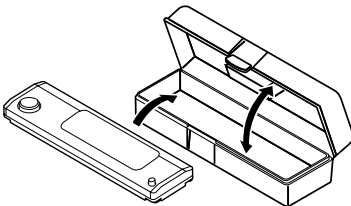

## Attaching the control panel

#### 1 Insert the left side of the control panel into the groove on the panel holder.

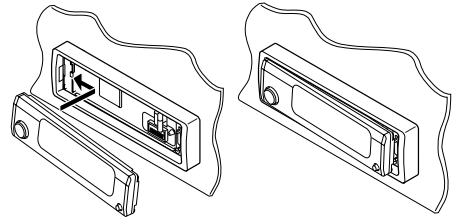

#### 2 Press the right side of the control panel to fix it to the panel holder.

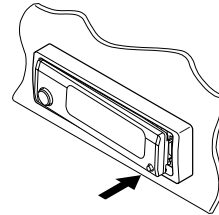

#### Note on cleaning the connectors:

If you frequently detach the control panel, the connectors will deteriorate.

To minimize this possibility, periodically wipe the connectors with a cotton swab or cloth moistened with alcohol, being careful not to damage the connectors.

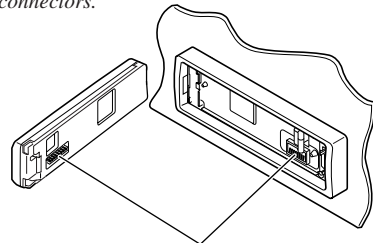

Connectors

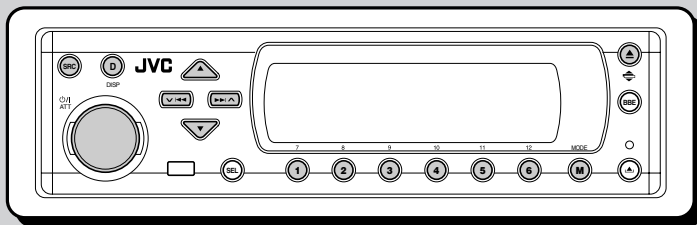
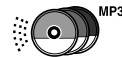

We recommend that you use the JVC MP3-compatible CD changer with your unit.

By using this CD changer, you can play back your original CD-Rs (Recordable) and CD-RWs (Rewritable) recorded either in audio CD format or in MP3 format.

- You can also connect other CH-X series CD changers (except CH-X99 and CH-X100). However, they are not compatible with MP3 discs, so you cannot play back MP3 discs.
- You cannot use the KD-MK series CD changers with this unit.

Before operating your CD changer:

- Refer also to the Instructions supplied with your CD changer.
- If no discs are in the magazine of the CD changer or the discs are inserted upside down, "No Disc" will appear on the display. If this happens, remove the magazine and set the discs correctly.
- If no magazine is loaded in the CD changer, "No Magazine" appears on the display. If this happens, insert the magazine in the CD changer.
- If "Reset 01" – "Reset 08" appears on the display, something is wrong with the connection between this unit and the CD changer. If this happens, check the connection and make sure the cords are connected firmly. Then, press the reset button of the CD changer.

**Note:**

You cannot control and play any WMA disc on the CD changer.

## Playing discs

### Select the CD automatic changer (CD-CH).



Each time you press the button, the source changes as described on page 7. When you select a source, the power automatically comes on.

Playback starts from the first track of the first disc, and all tracks of all discs are played back.

- When the current disc is an audio CD or a CD Text disc:

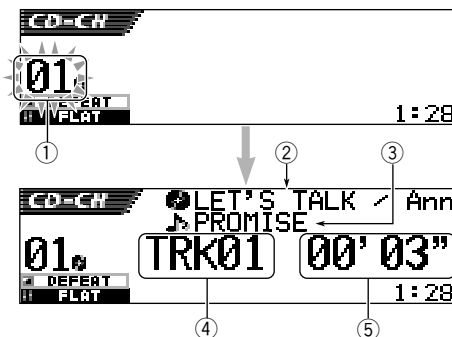



- ① Disc number
- ② Disc title/performer (if no title is recorded or assigned, "No Name" appears.)
- ③ Track title (if no title is recorded, "No Name" appears.)
- ④ Current track number
- ⑤ Elapsed playing time of the current track

CONTINUED ON THE NEXT PAGE

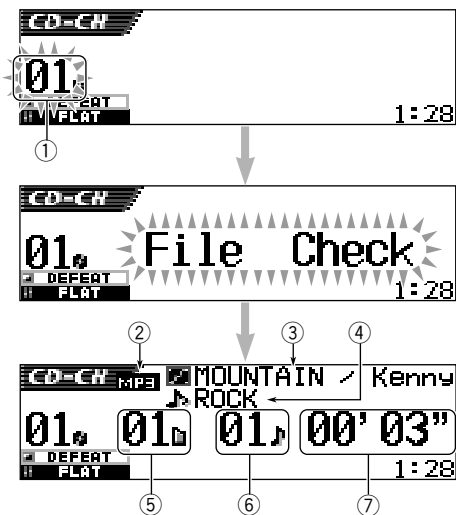
• When the current disc is an MP3 disc:



- ① Disc number
- ② Disc type—MP3
- ③ Album title/performer (or folder name  when “Tag” is set to “Off”—see page 41, or when no Tag is recorded)
- ④ Track title (or track name  when “Tag” is set to “Off”—see page 41, or when no Tag is recorded)
- ⑤ Current folder number
- ⑥ Current track number
- ⑦ Elapsed playing time of the current track

### To change the display pattern

By pressing DISP (D), you can change the information shown on the display.

Each time you press the button, the display patterns change.

- For details, see page 24.



### If you change the source or turn off the unit

Disc play also stops.

Next time you select “CD-CH” as the source, disc play starts from where it has been stopped previously.

### To go to a particular disc directly

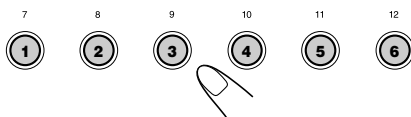

Press the number button corresponding to the disc number to start its playback (while the CD changer is playing).



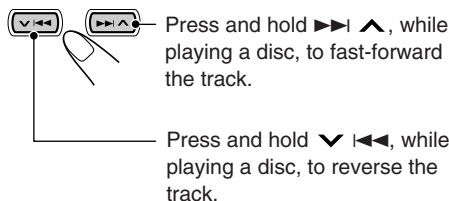

- To select a disc number from 1 – 6:  
Press 1 (7) – 6 (12) briefly.
- To select a disc number from 7 – 12:  
Press and hold 1 (7) – 6 (12) for more than 1 second.

### To fast-forward or reverse the track



Press and hold  , while playing a disc, to fast-forward the track.



Press and hold  , while playing a disc, to reverse the track.

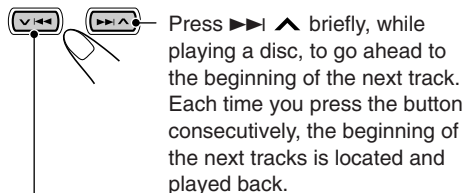

#### Note:

During this operation on an MP3 disc, you can only hear intermittent sounds. (The elapsed playing time also changes intermittently on the display.)

### To go to the next track or the previous tracks



Press   briefly, while playing a disc, to go ahead to the beginning of the next track. Each time you press the button consecutively, the beginning of the next tracks is located and played back.

Press   briefly, while playing a disc, to go back to the beginning of the current track. Each time you press the button consecutively, the beginning of the previous tracks is located and played back.



## To go to a track quickly

This operation is only possible when using JVC MP3-compatible CD changer CH-X1500.

- 1 Press MODE (M) while playing a disc.  
“Mode” appears on the display, and the number buttons and ▲ (up)/▼ (down) buttons start flashing.



While playing an audio CD or a CD Text disc:

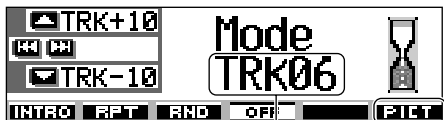

Current track number

See page 33 for this function.

While playing an MP3 disc:

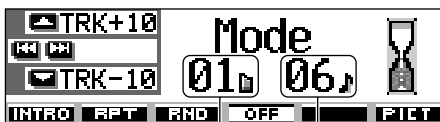

Current folder number

Current track number

- 2 Press ▲ (up) or ▼ (down), while “Mode” is still on the display.  
First time you press ▲ (up) or ▼ (down), the track skips to the nearest higher or lower track with a track number of multiple ten (ex. 10th, 20th, 30th).  
Then, each time you press the button, you can skip 10 tracks (see “How to go to the desired track quickly” that follows).
  - After the last track, the first track will be selected, and vice versa.
  - While playing an MP3 disc, this operation is possible only within a folder.

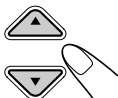

## How to go to the desired track quickly

- Ex. 1: To select track number 32 while playing track number 6

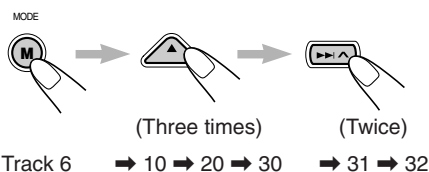

- Ex. 2: To select track number 8 while playing track number 36



## Locating a folder on a disc

The following operations are only possible when playing an MP3 disc using a JVC MP3-compatible CD changer, CH-X1500.

### To skip to the next or previous folder (either on the same or different hierarchy levels)

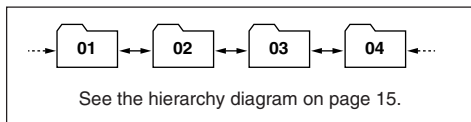

#### On the control panel:



Press ▲ (up) while playing a disc to skip to the next folder. Each time you press the button consecutively, the next folder is located and the first track in the folder starts playing.

Press ▼ (down) while playing a disc to skip back to the previous folder. Each time you press the button consecutively, the previous folder is located and the first track in the folder starts playing.

#### On the remote controller:

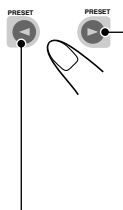

Press and hold ► (right) while playing a disc to skip to the next folder. Each time you press and hold the button consecutively, the next folder is located and the first track in the folder starts playing.

Press and hold ◀ (left) while playing a disc to skip back to the previous folder. Each time you press and hold the button consecutively, the previous folder is located and the first track in the folder starts playing.

#### Note:

If the folder does not contain any MP3 tracks, it is skipped.

### To skip to the next or previous folder within a folder (on the same hierarchy level)

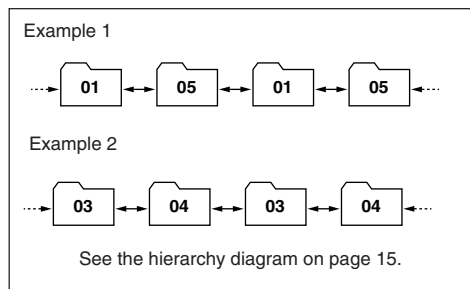

#### ONLY on the remote controller:

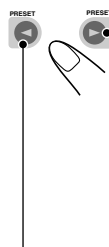

Press ► (right) while playing a disc to skip to the next folder. Each time you press the button consecutively, the next folder included within the same folder (on the same hierarchy level) is located (and the first track in the folder starts playing if recorded).

Press ◀ (left) while playing a disc to skip back to the previous folder. Each time you press the button consecutively, the previous folder included within the same folder (on the same hierarchy level) is located (and the first track in the folder starts playing if recorded).

#### Note:

If the folder does not contain any MP3 tracks, playback will not start ("No Music" appears on the display). Select another folder.

To go back to the root directly, press **R•D** on the remote controller. You can go back to the root from any folder.

- If tracks are recorded on the disc directly without putting them into a folder, this unit starts playing the tracks.

## Selecting a disc/folder/track using the name lists

### To select a disc using the disc lists

If you forget what discs are loaded in the CD changer, you can show the disc name list and select a disc in the list shown on the display.

- The display can show only six names at a time.

- While playing a disc, press and hold ▲ (up) or ▼ (down) until a disc name list appears on the display.

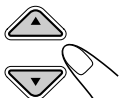

#### Note:

If a disc has a disc title (CD Text) or an assigned disc name, it will be shown on the display.

However, if the disc has not been played before, its disc number will appear.

- Press ▲ (up) or ▼ (down) to show the other disc name list, if necessary.

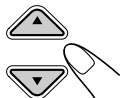

- Select the number (1 – 6) for the disc you want to play.

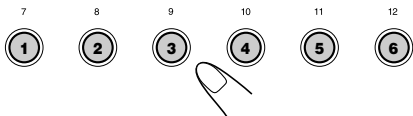

While playing an MP3 disc, you can also show the folder list(s) and track list(s) on the display, then select a folder or track.

- While playing an MP3 disc, press and hold ▲ (up) or ▼ (down) until a disc name list appears on the display.

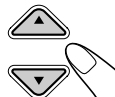

- Press ►► ▲ or ▼ ◀◀ to show a folder list of the current disc or track list of the current folder.

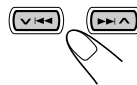

Each time you press the button, the lists on the display change as follows:

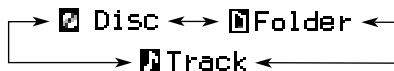

Ex. When folder list is selected

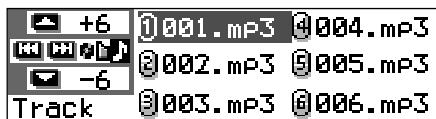

Ex. When track list is selected

#### Note:

The display can show only six names at a time. You can show the other names on the next lists by pressing ▲ (up) or ▼ (down).

- Press the number button for the disc, folder or track you want to play.

## Selecting playback modes

### To play back tracks at random (Random Play)

You can play back tracks on a disc, on all loaded discs (or in a folder for MP3 discs) at random.

- Press MODE (M) while playing a disc.  
 "Mode" appears on the display, then the number buttons and the ▲ (up)/▼ (down) buttons start flashing.



While playing an audio CD or a CD Text disc:



Current track number

While playing an MP3 disc:

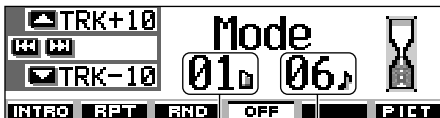

Current folder number

Current track number

- Press number button 3, while "Mode" is still on the display.  
 Each time you press the button, random play mode changes as follows:

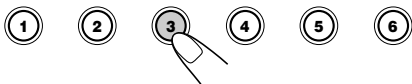
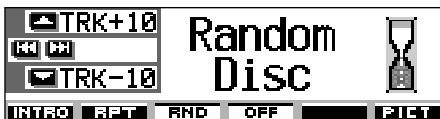



For audio CD and CD Text discs:

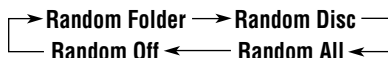

For MP3 discs:



Mode	Plays randomly
<b>Random Folder*</b> :	All tracks of the current folder, then moves to the next folder and so on. • While playing,  <b>RND</b> lights up on the display.
<b>Random Disc</b> :	All tracks on the disc. • While playing,  <b>RND</b> lights up on the display.
<b>Random All</b> :	All tracks of all discs inserted in the magazine. • While playing,  <b>ALL RND</b> lights up on the display.

\* "Random Folder" can be used for MP3 discs only.

To cancel Random Play, select "Random Off" by pressing number button 3 repeatedly or press number button 4 in step 2.

## To play back tracks repeatedly (Repeat Play)

You can play back a track, a disc (or a folder for MP3 discs) repeatedly.

- 1 Press MODE (M) while playing a disc.  
“Mode” appears on the display, then the number buttons and the ▲ (up)/▼ (down) buttons start flashing.



- 2 Press number button 2, while “Mode” is still on the display.  
Each time you press the button, repeat play mode changes as follows:

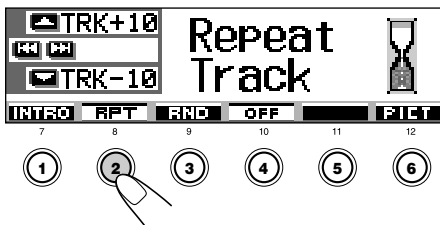

For audio CD and CD Text discs:



For MP3 discs:

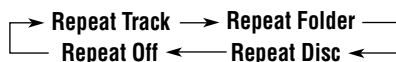

Mode	Plays repeatedly
<b>Repeat Track :</b>	Current or specified track.
	• While playing,  lights up on the display.
<b>Repeat Folder* :</b>	All tracks of the current (or specified) folder.
	• While playing,  lights up on the display
<b>Repeat Disc :</b>	All tracks of the current (or specified) disc.
	• While playing,  lights up on the display.

\* “Repeat Folder” can be used for MP3 discs only.

**To cancel Repeat Play**, select “Repeat Off” by pressing number button 2 repeatedly or press number button 4 in step 2.

## To play back only intros (Intro Scan)

You can play back the first 15 seconds of each track sequentially.

- 1 Press MODE (M) while playing a disc.  
“Mode” appears on the display, then the number buttons and the ▲ (up)/▼ (down) buttons start flashing.

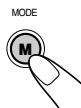

- 2 Press number button 1, while “Mode” is still on the display.  
Each time you press the button, intro scan mode changes as follows:

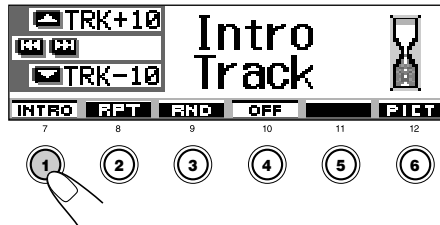

For audio CD and CD Text discs:



For MP3 discs:

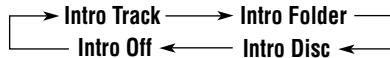

Mode	Plays the beginnings of
<b>Intro Track :</b>	All tracks of the disc.
	• While playing,  lights up on the display.
<b>Intro Folder* :</b>	First tracks of all folders of the current disc.
	• While playing,  lights up on the display.
<b>Intro Disc :</b>	First tracks of all inserted discs.
	• While playing,  lights up on the display.

\* “Intro Folder” can be used for MP3 discs only.

**To cancel Intro Scan**, select “Intro Off” by pressing number button 1 repeatedly or press number button 4 in step 2.



# EXTERNAL COMPONENT OPERATIONS

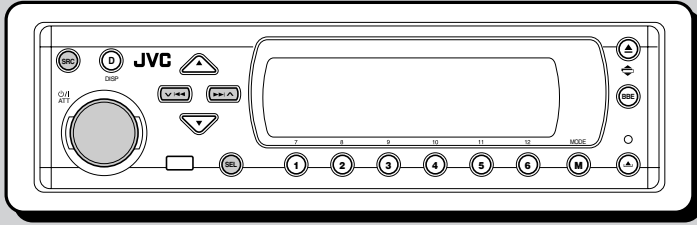

## Playing an external component

### For KD-SH9750:

You can connect an external components to the LINE IN plugs on the rear.

- If you cannot select "LINE IN" as the source, change the "Line in" setting to "On." (See pages 40 and 42.)

### For KD-SH9700:

You can connect the external component to the CD changer jack on the rear using the Line Input Adapter KS-U57 (not supplied).

- For connecting the Line Input Adapter KS-U57 and the external component, refer to the Installation/ Connection Manual (separate volume).
- Before operating the external component, change the "Ext Input" setting to "Line In." (See pages 40 and 42.)

### 1 Select the external component (LINE IN).



Each time you press the button, the source changes as described on page 7. When you select a source, the power automatically comes on.



If you have assigned a different name to the external component, it will appear.

### 2 Turn on the connected component and start playing the source.

### 3 Adjust the volume.

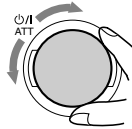

### 4 Select the DSP mode and sound mode as you want.

- For the DSP modes, see page 25.
- For the sound (iEQ) modes, see page 28.

#### Note:

When the source is "LINE IN," the DISP (D) button will not work.



## Sound modes (preset frequency level settings)

The list below shows the preset frequency level settings for each sound mode.

- You can adjust the preset sound modes temporarily. However, your temporary adjustments will be reset when you select another sound mode.

Sound Mode	Preset equalizing values						
	60 Hz	150 Hz	400 Hz	1 kHz	2.4 kHz	6 kHz	12 kHz
Flat	00	00	00	00	00	00	00
Hard Rock	+03	+03	+01	00	00	+02	+01
R & B	+03	+02	+02	00	+01	+01	+03
Pop	00	+02	00	00	+01	+01	+02
Jazz	+03	+02	+01	+01	+01	+03	+02
DanceMusic	+04	+02	00	-02	-01	+01	+01
Country	+02	+01	00	00	00	+01	+02
Reggae	+03	00	00	+01	+02	+02	+03
Classic	+02	+03	+01	00	00	+02	00
User 1	00	00	00	00	00	00	00
User 2	00	00	00	00	00	00	00
User 3	00	00	00	00	00	00	00

## Available characters

You can use the following characters to assign names to stations, CDs, and external component. (See page 44.)

### Capital letters

A	B	C	D	E
F	G	H	I	J
K	L	M	N	O
P	Q	R	S	T
U	V	W	X	Y
Z	space			

### Small letters

a	b	c	d	e
f	g	h	i	j
k	l	m	n	o
p	q	r	s	t
u	v	w	x	y
z	space			

### Numbers and symbols

0	1	2	3	4
5	6	7	8	9
!	"	#	\$	%
&	'	(	)	*
+	,	-	.	/
:	;	<	=	>
?	@	_	`	space



# TROUBLESHOOTING

ENGLISH

What appears to be trouble is not always serious. Check the following points before calling a service center.

	Symptoms	Causes	Remedies
General Playback	<ul style="list-style-type: none"> <li>• Sound is sometimes interrupted.</li> </ul>	You are driving on rough roads.	Stop playback while driving on rough roads.
		Disc is scratched.	Change the disc.
		Connections are incorrect.	Check the cords and connections.
	<ul style="list-style-type: none"> <li>• Sound cannot be heard from the speakers.</li> </ul>	The “PowerAmp” setting is set to “Off.”	Set it to “On” (see page 42).
		Connections are incorrect.	Check the cords and connections.
	<ul style="list-style-type: none"> <li>• CD-R/CD-RW cannot be played back.</li> <li>• Tracks on the CD-R/CD-RW cannot be skipped.</li> </ul>	Disc is inserted upside down.	Insert the disc correctly.
		CD-R/CD-RW is not finalized.	<ul style="list-style-type: none"> <li>• Insert a finalized CD-R/CD-RW.</li> <li>• Finalize the CD-R/CD-RW with the component which you used for recording.</li> </ul>
	<ul style="list-style-type: none"> <li>• Disc cannot be ejected.</li> </ul>	Disc is locked.	Unlock the disc (see page 23.)
	<ul style="list-style-type: none"> <li>• Disc cannot be recognized (“No Disc,” “Loading Error,” or “Eject Error” flashes).</li> </ul>	The CD player may function incorrectly.	While holding <b>⏏/ATT</b> , press <b>▲</b> for more than 2 seconds to eject the disc.
	<ul style="list-style-type: none"> <li>• This unit does not work at all.</li> </ul>	The built-in microcomputer may have functioned incorrectly due to noise, etc.	Press the reset button on the control panel using a ball-point pen (see page 2).
<ul style="list-style-type: none"> <li>• When “Reset P00” to “Reset P44” appears on the display.</li> </ul>	There is something is blocking the control panel movement.	Press the reset button on the control panel using a ball-point pen (see page 2). If the reset button does not work. Check the installation. (Ex. you have used a screws which are longer than specified.)	
<ul style="list-style-type: none"> <li>• <b>INPUT OVER</b> (INPUT OVER) indicator appears on the display.</li> <li>• “Panel Connect Error” appears on the display.</li> </ul>	Input level through the external component (LINE IN) is too high.	Adjust the output level on the external component.	
	The control panel is not attached correctly and firmly.	Remove the control panel, wipe the connectors, then attach it again (see page 46).	
FM/AM	<ul style="list-style-type: none"> <li>• SSM automatic preset does not work.</li> </ul>	Signals are too weak.	Store stations manually.
	<ul style="list-style-type: none"> <li>• Static noise while listening to the radio.</li> </ul>	The antenna is not connected firmly.	Connect the antenna firmly.





Symptoms	Causes	Remedies	
<ul style="list-style-type: none"> <li>Download does not seem to finish.</li> </ul>	You are trying to download an animation of many frames.	This is normal (see page 33).	Graphics
<ul style="list-style-type: none"> <li>Animation does not move.</li> </ul>	Temperature in the car compartment is very low— LOW TEMP. (LOW TEMP.) indicator appears.	Wait until the operating temperature resumes—until LOW TEMP. (LOW TEMP.) indicator goes off.	
<ul style="list-style-type: none"> <li>“Movie” category settings in the PSM do not take effect.</li> </ul>			
<ul style="list-style-type: none"> <li>“No Disc” flashes on the display .</li> </ul>	No disc in the magazine.	Insert a disc.	CD Changer
<ul style="list-style-type: none"> <li>“Reset 08” flashes on the display .</li> </ul>	This unit is not connected to a CD changer correctly.	Connect this unit and the CD changer correctly and press the reset button of the CD changer.	
<ul style="list-style-type: none"> <li>“Reset 01” – “Reset 07” flashes on the display.</li> </ul>	_____	Press the reset button of the CD changer.	
<ul style="list-style-type: none"> <li>Disc cannot be played back.</li> </ul>	MP3/WMA tracks do not have the extension code—mp3 or wma in their file names.	Add the extension code—mp3 or wma to their file names.	MP3/WMA Playback
	MP3/WMA tracks are not recorded in the format compliant with ISO 9660 Level 1, ISO 9660 Level 2, Romeo, or Joliet.	Change the disc. (Record MP3/WMA tracks using a compliant application.)	
<ul style="list-style-type: none"> <li>“Unplayable File” appears and tracks skip.</li> </ul>	Tracks are not encoded in an appropriate format.	Insert a disc that contains tracks encoded in an appropriate format.	
	WMA tracks are copy-protected.	This is normal. Copy-protected tracks cannot be played back.	
<ul style="list-style-type: none"> <li>Noise is generated.</li> </ul>	The track played back is not an MP3/WMA file (although it has the extension code—mp3 or wma).	Skip to another track or change the disc. (Do not add the extension code—mp3 or wma to non-MP3 or WMA files.)	
<ul style="list-style-type: none"> <li>Elapsed playing time is not correct.</li> </ul>	This sometimes occurs during play. This is caused by how the tracks are recorded on the disc.	Select another folder.	
<ul style="list-style-type: none"> <li>“No Files” appears on the display for a while, then the disc ejects.</li> </ul>	The current MP3/WMA disc does not contain any MP3/WMA tracks.	Insert a disc that contains MP3/WMA tracks.	
<ul style="list-style-type: none"> <li>“No Music” appears on the display.</li> </ul>	No MP3/WMA tracks are included in the folder.	Select another folder including MP3/WMA tracks.	
	Only <jml> and/or <jma> files are recorded on the disc.	Insert a disc including MP3 or WMA tracks.	
<ul style="list-style-type: none"> <li>Correct characters are not displayed. (e.g. album name)</li> </ul>	This unit can only display alphabets (capital: A–Z, small: a–z), numbers, and a limited number of symbols.	_____	



## Handling discs

This unit has been designed to reproduce CDs, CD-Rs (Recordable), CD-RWs (Rewritable), and CD Texts.

- This unit is also compatible with MP3 and WMA discs.

### How to handle discs

#### When removing a disc from its case, press down the center holder and lift the disc out, holding it by the edges.

Always hold the disc by the edges. Do not touch its recording surface.

- Always hold the disc by the edges. Do not touch its recording surface.

Center holder



When storing a disc into its case, gently insert the disc around the center holder (with the printed surface facing up).

- Make sure to store discs into the cases after use.

### To keep discs clean

A dirty disc may not play correctly. If a disc does become dirty, wipe it with a soft cloth in a straight line from center to edge.



### To play new discs

New discs may have some rough spots around the inner and outer edges. If such a disc is used, this unit may reject the disc.

To remove these rough spots, rub the edges with a pencil or ball-point pen, etc.



### Moisture condensation

Moisture may condense on the lens inside the CD player in the following cases:

- After starting the heater in the car.
- If it becomes very humid inside the car.

Should this occur, the CD player may malfunction. In this case, eject the disc and leave the unit turned on for a few hours until the moisture evaporates.

### When playing a CD-R or CD-RW

Before playing back CD-Rs or CD-RWs, read their instructions or cautions carefully.

- Use only "finalized" CD-Rs or CD-RWs.
- Some CD-Rs or CD-RWs may not play back on this unit because of their disc characteristics, and for the following reasons:
  - Discs are dirty or scratched.
  - Moisture condensation on the lens inside the unit.
  - The pickup lens inside the unit is dirty.
- CD-RWs may require a longer readout time since the reflectance of CD-RWs is lower than that of regular CDs.
- CD-Rs or CD-RWs are susceptible to high temperatures or high humidity, so do not leave them inside your car.
- Do not use following CD-Rs or CD-RWs:
  - Discs with stickers, labels, or protective seal stuck to the surface.
  - Discs on which labels can be directly printed by an ink jet printer.

Using these discs under high temperatures or high humidity may cause malfunctions or damage to discs. For example,

- Stickers or labels may shrink and warp a disc.
- Stickers or labels may peel off so discs cannot be ejected.
- Print on discs may get sticky.

Read instructions or cautions about labels and printable discs carefully.

#### CAUTIONS:

- Do not insert 8 cm (3-3/16") discs (single CDs) into the loading slot. (Such discs cannot be ejected.)
- Do not insert any disc of unusual shape—like a heart or flower; otherwise, it will cause a malfunction.
- Do not expose discs to direct sunlight or any heat source or place them in a place subject to high temperature and humidity. Do not leave them in a car.
- Do not use any solvent (for example, conventional record cleaner, spray, thinner, benzene, etc.) to clean discs.

Warped disc



Sticker



Sticker residue

Disc



Stick-on label

## AUDIO AMPLIFIER SECTION

Maximum Power Output:

Front: 50 W per channel

Rear: 50 W per channel

Continuous Power Output (RMS):

Front: 19 W per channel into 4  $\Omega$ , 40 Hz to 20 000 Hz at no more than 0.8% total harmonic distortion.

Rear: 19 W per channel into 4  $\Omega$ , 40 Hz to 20 000 Hz at no more than 0.8% total harmonic distortion.

Load Impedance: 4  $\Omega$  (4  $\Omega$  to 8  $\Omega$  allowance)

Equalizer Control Range:

Frequencies: 60 Hz, 150 Hz, 400 Hz, 1 kHz, 2.4 kHz, 6 kHz, 12 kHz

Level:  $\pm 10$  dB

Frequency Response: 40 Hz to 20 000 Hz

Signal-to-Noise Ratio: 70 dB

Line-In Level/Impedance (KD-SH9750 only):

LINE IN: 1.5 V/20 k $\Omega$  load

Line-Out Level/Impedance:

KD-SH9750: 4.0 V/20 k $\Omega$  load (full scale)

KD-SH9700: 2.0 V/20 k $\Omega$  load (full scale)

Output Impedance: 1 k $\Omega$

## TUNER SECTION

Frequency Range:

FM: 87.5 MHz to 107.9 MHz  
(with channel interval set to 200 kHz)  
87.5 MHz to 108.0 MHz  
(with channel interval set to 50 kHz)

AM: 530 kHz to 1 710 kHz  
(with channel interval set to 10 kHz)  
531 kHz to 1 602 kHz  
(with channel interval set to 9 kHz)

### **[FM Tuner]**

Usable Sensitivity: 11.3 dBf (1.0  $\mu$ V/75  $\Omega$ )  
50 dB Quieting Sensitivity: 16.3 dBf (1.8  $\mu$ V/75  $\Omega$ )  
Alternate Channel Selectivity (400 kHz): 65 dB  
Frequency Response: 40 Hz to 15 000 Hz  
Stereo Separation: 35 dB  
Capture Ratio: 1.5 dB

### **[AM Tuner]**

Sensitivity: 20  $\mu$ V  
Selectivity: 35 dB

## CD PLAYER SECTION

Type: Compact disc player

Signal Detection System: Non-contact optical pickup (semiconductor laser)

Number of channels: 2 channels (stereo)

Frequency Response: 5 Hz to 20 000 Hz

Dynamic Range: 98 dB

Signal-to-Noise Ratio: 102 dB

Wow and Flutter: Less than measurable limit

MP3 (MPEG Audio Layer 3)

Max. Bit rate: 320 Kbps

WMA (Windows Media<sup>®</sup> Audio)

Max. Bit rate: 192 Kbps

## GENERAL

Power Requirement:

Operating Voltage: DC 14.4 V  
(11 V to 16 V allowance)

Grounding System: Negative ground

Allowable Operating Temperature:  
0°C to +40°C (32°F to 104°F)

Dimensions (W  $\times$  H  $\times$  D):

Installation Size:

182 mm  $\times$  52 mm  $\times$  161 mm  
(7-3/16"  $\times$  2-1/16"  $\times$  6-3/8")

Panel Size:

188 mm  $\times$  58 mm  $\times$  17 mm  
(7-7/16"  $\times$  2-5/16"  $\times$  11/16")

Mass: 1.8 kg (4.0 lbs)  
(excluding accessories)

*Design and specifications are subject to change without notice.*

If a kit is necessary for your car, consult your telephone directory for the nearest car audio speciality shop.



**JVC**

**MOBILE**  
ENTERTAINMENT

<http://www.jvcmobile.com>

*Visit us on-line for*

*Technical Support & Customer Satisfaction Survey.*

**US RESIDENTS ONLY**

**Having TROUBLE with operation?**

**Please reset your unit**

Refer to page of How to Reset

**Still having trouble??**

**USA ONLY**

**Call 1-800-252-5722**

<http://www.jvc.com>

**We can help you!**

**JVC**

VICTOR COMPANY OF JAPAN, LIMITED



EN, SP, FR

© 2003 VICTOR COMPANY OF JAPAN, LIMITED



0203MNMDWJEIN

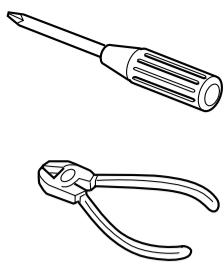

#### ENGLISH

- This unit is designed to operate on 12 V DC, NEGATIVE ground electrical systems.

## INSTALLATION (IN-DASH MOUNTING)

- The following illustration shows a typical installation. However, you should make adjustments corresponding to your specific car. If you have any questions or require information regarding installation kits, consult your JVC car audio dealer or a company supplying kits.

- 1 Before mounting:** Press (Control Panel Release button) to detach the control panel if already attached.  
\* When shipped from the factory, the control panel is packed in the hard case.
- 2** Remove the trim plate.
- 3** Remove the sleeve after disengaging the sleeve locks.
  - Stand the unit.  
**Note:** When you stand the unit, be careful not to damage the fuse on the rear.
  - Insert the 2 handles between the unit and the sleeve, as illustrated, to disengage the sleeve locks.
  - Remove the sleeve.  
**Note:** Be sure to keep the handles for future use after installing the unit.
- 4** Install the sleeve into the dashboard.  
\* After the sleeve is correctly installed in the dashboard, bend the appropriate tabs to hold the sleeve firmly in place, as illustrated.
- 5** Fix the mounting bolt to the rear of the unit's body and place the rubber cushion over the end of the bolt.
- 6** Do the required electrical connections.
- 7** Slide the unit into the sleeve.
- 8** Attach the trim plate.
- 9** Attach the control panel.

#### ESPAÑOL

- Esta unidad está diseñada para funcionar con 12 V de CC, con sistemas eléctricos de masa NEGATIVA.

## INSTALACION (MONTAJE EN EL TABLERO DE INSTRUMENTOS)

- La siguiente ilustración muestra una instalación típica. Sin embargo usted deberá efectuar los ajustes correspondientes a su automóvil. Si tiene alguna pregunta o necesita información acerca de las herramientas para instalación, consulte con su concesionario de JVC de equipos de audio para automóviles o a una compañía que suministra tales herramientas.

- 1 Antes de instalar:** Pulse (botón de liberación del panel de control) para desenganchar el panel de control, si ya está fijado.  
\* El panel de control se expide de fábrica dentro del estuche duro.
- 2** Retire la placa de guarnición.
- 3** Retire la cubierta después de desenganchar los retenes de la cubierta.
  - Ponga la unidad vertical.  
**Nota:** Al poner la unidad vertical, tenga cuidado de no dañar el fusible provisto en la parte posterior.
  - Inserte las dos manijas entre la unidad y la cubierta tal como en la ilustración y desenganche los retenes de la cubierta.
  - Retire la cubierta.  
**Nota:** Después de instalar la unidad, asegúrese de guardar las manijas para uso futuro.
- 4** Instale la cubierta en el tablero de instrumentos.  
\* Después de que la cubierta esté correctamente instalada en el tablero de instrumentos, doble las lengüetas correspondientes para sostener la cubierta firmemente en su lugar, tal como se muestra.
- 5** Fije el perno de montaje en la parte trasera del cuerpo de la unidad y coloque el cojín de goma sobre el extremo del perno.
- 6** Realice las conexiones eléctricas requeridas.
- 7** Deslice la unidad dentro de la cubierta hasta que quede trabada.
- 8** Coloque la placa de guarnición.
- 9** Coloque el panel de control.

#### FRANÇAIS

- Cet appareil est conçu pour fonctionner sur des sources de courant continu de 12 V à masse NEGATIVE.

## INSTALLATION (MONTAGE DANS LE TABLEAU DE BORD)

- L'illustration suivante est un exemple d'installation typique. Cependant, vous devez faire les ajustements correspondant à votre voiture particulière. Si vous avez des questions ou avez besoin d'information sur des kits d'installation, consulter votre revendeur d'autoradios JVC ou une compagnie d'approvisionnement.

- 1 Avant le montage:** Appuyer sur (déblocage du panneau de commande) pour éventuellement détacher le panneau de commande.  
\* Lorsque ce panneau de commande sort d'usine, il est rangé dans un étui de transport.
- 2** Retirer la plaque d'assemblage.
- 3** Libérer les verrous du manchon et retirer le manchon.
  - Poser l'appareil à la verticale.  
**Remarque:** Lorsque vous mettez l'appareil à la verticale, faire attention de ne pas endommager le fusible situé sur l'arrière.
  - Insérer les 2 poignées entre l'appareil et le manchon comme indiqué pour désengager les verrous de manchon.
  - Retirer le manchon.  
**Remarque:** S'assurer de garder les poignées pour une utilisation ultérieure, après l'installation de l'appareil.
- 4** Installer le manchon dans le tableau de bord.  
\* Après installation correcte du manchon dans le tableau de bord, plier les bonnes pattes pour maintenir fermement le manchon en place, comme montré.
- 5** Monter le boulon de montage sur l'arrière du corps de l'appareil puis passer l'amortisseur en caoutchouc sur l'extrémité du boulon.
- 6** Réaliser les connexions électriques.
- 7** Faites glisser l'appareil dans le manchon jusqu'à ce qu'il soit verrouillé.
- 8** Attachez la plaque d'ajustage.
- 9** Remonter le panneau de commande.

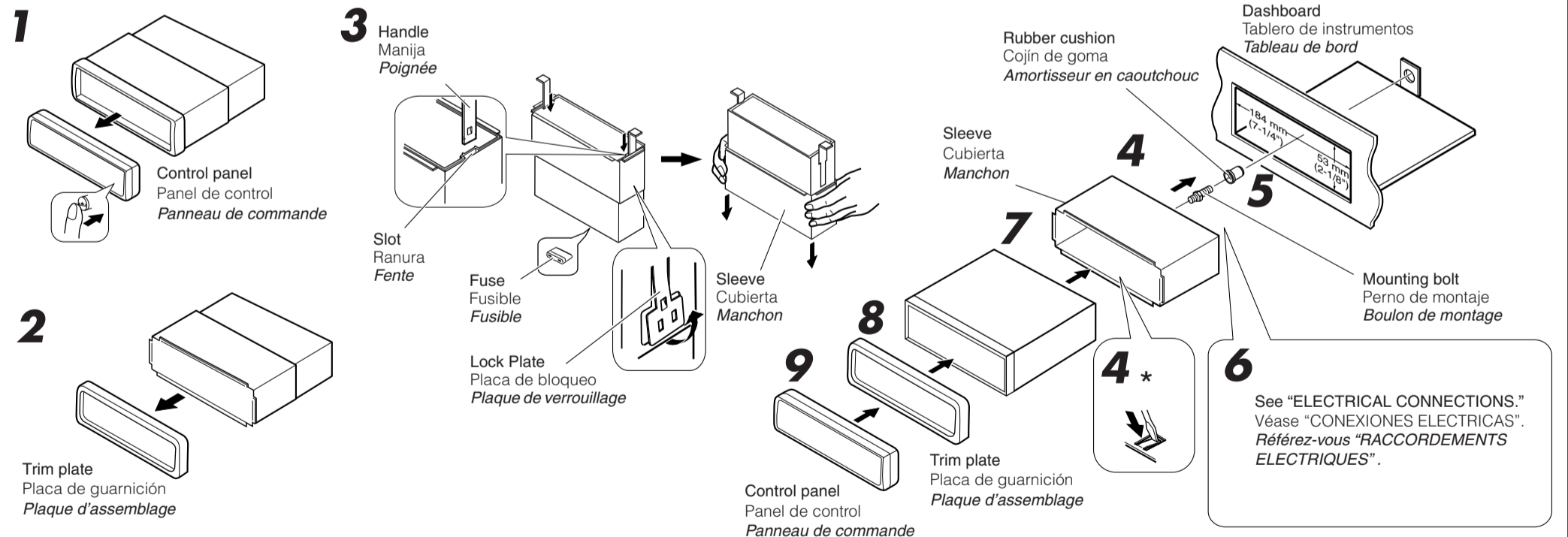

## TROUBLESHOOTING

- The fuse blows.**  
\* Are the red and black leads connected correctly?
- Power cannot be turned on.**  
\* Is the yellow lead connected?
- No sound from the speakers.**  
\* Is the speaker output lead short-circuited?
- Sound is distorted.**  
\* Is the speaker output lead grounded?
- \* Are the "-" terminals of L and R speakers grounded in common?
- Unit becomes hot.**  
\* Is the speaker output lead grounded?
- \* Are the "-" terminals of L and R speakers grounded in common?

## LOCALIZACION DE AVERIAS

- El fusible se quema.**  
\* ¿Están los conductores rojo y negro correctamente conectados?
- No es posible conectar la alimentación.**  
\* ¿Está el cable amarillo conectado?
- No sale sonido de los altavoces.**  
\* ¿Está el cable de salida del altavoz cortocircuitado?
- El sonido presenta distorsión.**  
\* ¿Está el cable de salida del altavoz conectado a masa?
- \* ¿Están los terminales "-" de los altavoces L y R conectados a una masa común?
- La unidad se calienta.**  
\* ¿Está el cable de salida del altavoz conectado a masa?
- \* ¿Están los terminales "-" de los altavoces L y R conectados a una masa común?

## EN CAS DE DIFFICULTES

- Le fusible saute.**  
\* Les fils rouge et noir sont-ils raccordés correctement?
- L'appareil ne peut pas être mise sous tension.**  
\* Le fil jaune est-elle raccordée?
- Pas de son des enceintes.**  
\* Le fil de sortie de d'enceinte est-il court-circuité?
- Le son est déformé.**  
\* Le fil de sortie de d'enceinte est-il à la masse?
- \* Les bornes "-" des enceintes gauche et droit sont-elles mises ensemble à la masse?
- L'appareil devient chaud.**  
\* Le fil de sortie de d'enceinte est-il à la masse?
- \* Les bornes "-" des enceintes gauche et droit sont-elles mises ensemble à la masse?



- When using the optional stay
- Cuando emplea un soporte opcional
- Lors de l'utilisation du hauban en option

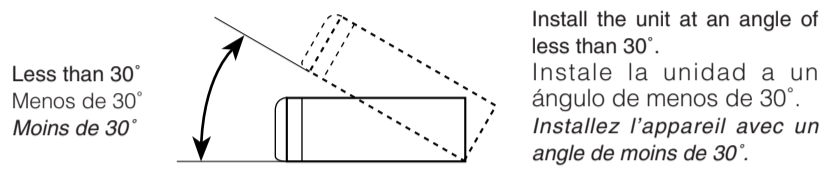
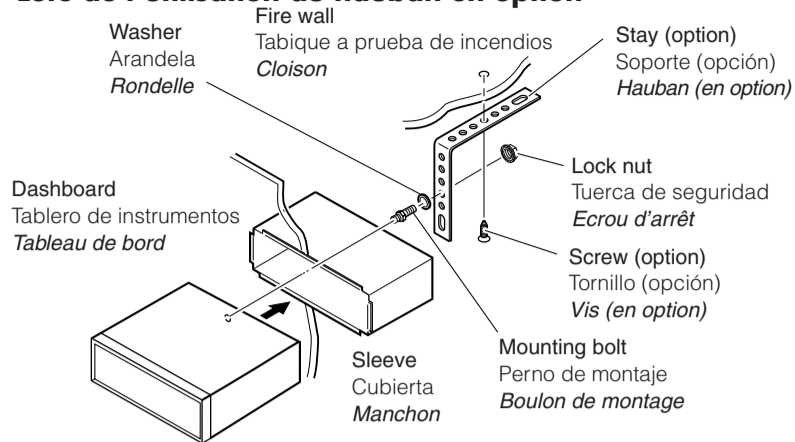

- When installing the unit without using the sleeve
- Instalación de la unidad sin utilizar la cubierta
- Lors de l'installation de l'appareil sans utiliser de manchon

In a Toyota for example, first remove the car radio and install the unit in its place.  
En un Toyota por ejemplo, primero extraiga la radio del automóvil y luego instale la unidad en su lugar.  
*Par exemple dans une Toyota, retirer d'abord l'autoradio et installer l'appareil à la place.*

Flat type screws—M5 x 6 mm (M5 x 1/4")\*  
Tornillos tipo plano—M5 x 6 mm (M5 x 1/4 pulgada)\*  
Vis à tête plate—M5 x 6 mm (M5 x 1/4 pouces)\*

\* Not included with this unit.  
\* No suministrado con esta unidad.  
\* Non fourni avec cet appareil.

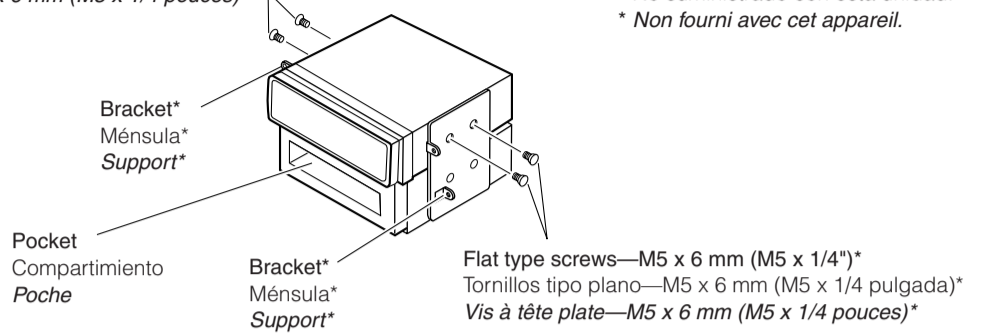

**Note** : When installing the unit on the mounting bracket, make sure to use the 6 mm (1/4")-long screws. If longer screws are used, they could damage the unit.  
**Nota** : Cuando instala la unidad en la ménsula de montaje, asegúrese de utilizar los tornillos de 6 mm (1/4 pulgada) de longitud. Si se utilizan tornillos más largos, éstos pueden dañar la unidad.  
**Remarque**: Lors de l'installation de l'appareil sur le support de montage, s'assurer d'utiliser des vis d'une longueur de 6 mm (1/4 pouces). Si des vis plus longues sont utilisées, elles peuvent endommager l'appareil.

### Removing the unit

- 1 Before removing the unit, release the rear section.
- 1 Remove the control panel.
- 2 Remove the trim plate.
- 3 Insert the 2 handles into the slots, as shown. Then, while gently pulling the handles away from each other, slide out the unit. (Be sure to keep the handles after installing it.)

### Extracción de la unidad

- 1 Antes de extraer la unidad, libere la sección trasera.
- 1 Extraiga el panel de control.
- 2 Retire la placa de guarnición.
- 3 Inserte las 2 manijas entre las ranuras, como se muestra. Luego, separe suavemente las manijas y extraiga la unidad. (Asegúrese de conservar las manijas después de instalarlo.)

### Retrait de l'appareil

- 1 Avant de retirer l'appareil, libérer la section arrière.
- 1 Retirer le panneau de commande.
- 2 Retirer la plaque d'assemblage.
- 3 Introduire les deux poignées dans les fentes, comme montré. Puis, tout en tirant doucement les poignées écartées, faire glisser l'appareil pour le sortir. (S'assurer de conserver les poignées après l'installation de l'appareil.)

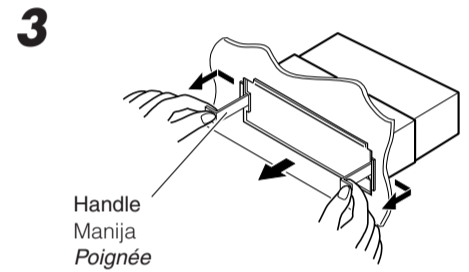
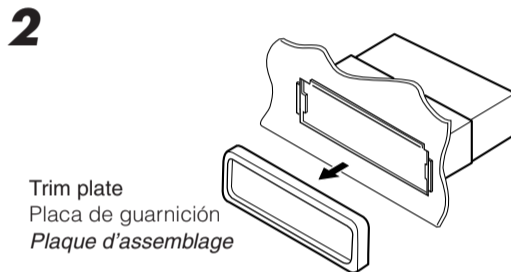
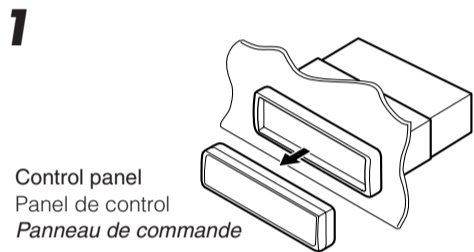

### Parts list for installation and connection

The following parts are provided with this unit. After checking them, please set them correctly.

Hard case/Control panel  
Estuche duro/Panel de control  
Etui de transport/Panneau de commande

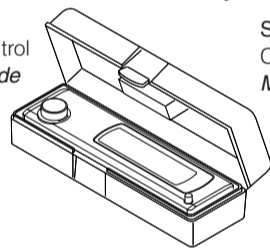

Sleeve  
Cubierta  
Manchon

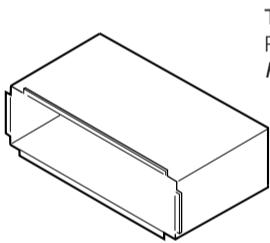

### Lista de piezas para instalación y conexión

Con esta unidad se suministran las siguientes piezas. Después de inspeccionarlas, colóquelas correctamente.

Trim plate  
Placa de guarnición  
Plaque d'assemblage

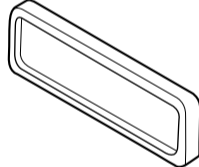

Remote controller  
Control remoto  
Télécommande

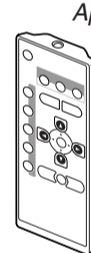

### Liste des pièces pour l'installation et raccordement

Les pièces suivantes sont fournies avec cet appareil. Après vérification, veuillez les placer correctement.

Battery  
Pila  
Pile



CR2025

Power cord  
Cordón de alimentación  
Cordon d'alimentation

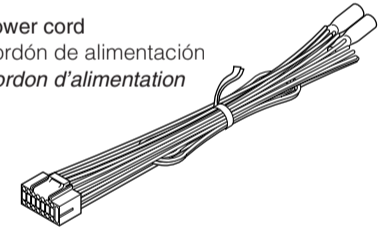

CD-ROM (Image Converter)  
CD-ROM (Image Converter)  
CD-ROM (Image Converter)



Handles  
Manijas  
Poignées



Washer—ø5  
Arandela—ø5  
Rondelle—ø5



Lock nut—M5  
Tuerca de seguridad—M5  
Ecrou d'arrêt—M5



Mounting bolt  
—M5 x 20 mm (M5 x 13/16")  
Perno de montaje  
—M5 x 20 mm (M5 x 13/16 pulgada)  
Boulon de montage  
—M5 x 20 mm (M5 x 13/16 pouces)



Rubber cushion  
Cojín de goma  
Amortisseur en caoutchouc



## ELECTRICAL CONNECTIONS

To prevent short circuits, we recommend that you disconnect the battery's negative terminal and make all electrical connections before installing the unit. If you are not sure how to install this unit correctly, have it installed by a qualified technician.

### Note:

This unit is designed to operate only on **12 V DC, NEGATIVE ground electrical systems**. If your vehicle does not have this system, a voltage inverter is required, which can be purchased at JVC car audio dealers.

- Replace the fuse with one of the specified rating. If the fuse blows frequently, consult your JVC car audio dealer.
- If noise is a problem...

This unit incorporates a noise filter in the power circuit. However, with some vehicles, clicking or other unwanted noise may occur. If this happens, connect the unit's **rear ground terminal** (see connection diagram) to the car's chassis using shorter and thicker cords, such as copper braiding or gauge wire. If noise still persists, consult your JVC car audio dealer.

- Maximum input of the speakers should be more than 50 W at the rear and 50 W at the front, with an impedance of **4 Ω to 8 Ω**.
- **Be sure to ground this unit to the car's chassis.**
- The heat sink becomes very hot after use. Be careful not to touch it when removing this unit.

Heat sink  
Sumidero térmico  
Dissipateur de chaleur

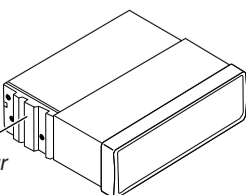

## CONEXIONES ELECTRICAS

Para evitar cortocircuitos, recomendamos que desconecte el terminal negativo de la batería y que efectúe todas las conexiones eléctricas antes de instalar la unidad. Si usted no está seguro de cómo instalar correctamente la unidad, hágala instalar por un técnico cualificado.

### Nota:

Esta unidad está diseñada para funcionar con **12 V de CC, con sistemas eléctricos de masa NEGATIVA** solamente. Si su vehículo no posee este sistema, será necesario un inversor de tensión, que puede ser adquirido en los concesionarios de JVC de equipos de audio para automóviles.

- Reemplace el fusible por uno con la corriente especificada. Si el fusible se quemase frecuentemente consulte con su concesionario de JVC de equipos de audio para automóviles.
- Si el ruido fuese un problema...  
Esta unidad tiene un filtro de ruido en el circuito de alimentación. Sin embargo, en algunos vehículos, pueden producirse chasquidos u otros ruidos indeseados. En tal caso conecte el **terminal de tierra posterior** (véase diagrama de conexión) del receptor al chasis del automóvil, utilizando cordones más gruesos y cortos tales como alambre de cobre trenzado o de grueso calibre. Si el ruido persiste, consulte a su concesionario de JVC de equipos de audio para automóvil.
- La entrada máxima de los altavoces debe ser de más de 50 W en el trasero y 50 W en la frontal, con una impedancia de **4 Ω a 8 Ω**.
- **Asegúrese de conectar esta unidad a tierra en el chasis del automóvil.**
- El sumidero térmico estará muy caliente después del uso. Asegúrese de no tocarlo al desmontar esta unidad.

## RACCORDEMENTS ELECTRIQUES

Pour éviter tout court-circuit, nous vous recommandons de débrancher la borne négative de la batterie et d'effectuer tous les raccordements électriques avant d'installer l'appareil. Si l'on n'est pas sûr de pouvoir installer correctement cet appareil, le faire installer par un technicien qualifié.

### Remarque:

Cet appareil est conçu pour fonctionner sur des sources de courant continu de **12 V à masse NEGATIVE** seulement. Si votre véhicule n'offre pas ce type d'alimentation, il vous faut un convertisseur de tension, que vous pouvez acheter chez un revendeur d'autoradios JVC.

- Remplacer le fusible par un de la valeur précisée. Si le fusible saute souvent, consulter votre revendeur d'autoradios JVC.
- Si le bruit est un problème...  
Cet appareil incorpore un filtre de bruit dans le circuit d'alimentation. Cependant, avec certains véhicules, quelques claquements ou autres bruits non désirés risquent de se produire. Si cela arrive, raccorder la **borne arrière de masse** de l'appareil au châssis de la voiture (voir le schéma de raccordement) en utilisant des cordons les plus gros et les plus courts possibles telle qu'une barre de cuivre ou une tresse. Si le bruit persiste, consulter votre revendeur d'autoradios JVC.
- La puissance admissible des enceintes devrait supérieure à 50 W à l'arrière et à 50 W l'avant, avec une impédance de **4 Ω à 8 Ω**.
- **S'assurer de raccorder la mise à la masse de cet appareil au châssis de la voiture.**
- Le dissipateur de chaleur devient très chaud après usage. Faire attention de ne pas le toucher en retirant cet appareil.



**A Typical Connections / Conexiones típicas / Raccordements typiques**

**Before connecting:** Check the wiring in the vehicle carefully not to fail in connecting this unit. Incorrect connection may cause a serious damage to this unit. The leads of the power cord and those of the connector from the car body may be different in color.

- 1 Connect the colored leads of the power cord to the car battery, speakers and automatic antenna (if any) in the following sequence.
  - 1 Black: ground
  - 2 Yellow: to car battery (constant 12 V)
  - 3 Red: to an accessory terminal
  - 4 Blue: to automatic antenna if any (250 mA max.)
  - 5 Blue with white stripe: to remote lead of other equipment (200 mA max.)
  - 6 Orange with white stripe: to car light control switch
  - 7 Others: to speakers
- 2 Connect the antenna cord.
- 3 Finally connect the wiring harness to the unit.

**Antes de la conexión:** Verifique atentamente el conexionado del vehículo para no cometer errores al conectar esta unidad. Una conexión incorrecta podría producir daños graves en la unidad. Los cordones del cable de alimentación y los del conector procedentes de la carrocería del automóvil podrían ser de diferentes en color.

- 1 Conecte los conductores de color del cable de alimentación a la batería del automóvil, altavoces y antena automática (si la hubiere) en la secuencia siguiente.
  - 1 Negro: a tierra
  - 2 Amarillo: a la batería del automóvil (12 V constantes)
  - 3 Rojo: a un terminal de accesorio
  - 4 Azul: a la antena automática si la hubiere (250 mA máx.)
  - 5 Azul con rayas blancas: Al conductor remoto de otro equipo (200 mA máx.)
  - 6 Naranja con rayas blancas: al interruptor de control de las luces del automóvil
  - 7 Otros: a los altavoces
- 2 Conecte el cable de antena.
- 3 Por último, conecte a la unidad el cableado preformado.

**Avant de commencer la connexion:** vérifiez attentivement le câblage du véhicule pour ne pas connecter incorrectement cet appareil. Une connexion incorrecte peut endommager sérieusement l'appareil.

Le fil du cordon d'alimentation et ceux des connecteurs du châssis de la voiture peuvent être différents en couleur.

- 1 Connectez les fils de couleur du cordon d'alimentation à la batterie de la voiture, aux enceintes et à l'antenne automatique (s'il y en a une) dans l'ordre suivant.
  - 1 Noir: a la masse
  - 2 Jaune: a la batterie de la voiture (12 V constant)
  - 3 Rouge: à la prise accessoire
  - 4 Bleu: À l'antenne automatique s'il y en a une (250 mA max.)
  - 5 Bleu avec bande blanche: au fil de télécommande de l'autre appareil (200 mA max.)
  - 6 Orange avec bande blanche: à l'interrupteur d'éclairage de la voiture
  - 7 Autres fils: aux enceintes
- 2 Connectez le cordon d'antenne.
- 3 Finalement, connectez le faisceau de fils à l'appareil.

Before connecting the CD changer, make sure that the unit is turned off. Antes de conectar el cambiador de CD, asegúrese de que la unidad esté apagada. Avant de connecter le changeur CD, s'assurer que l'unité est éteinte.

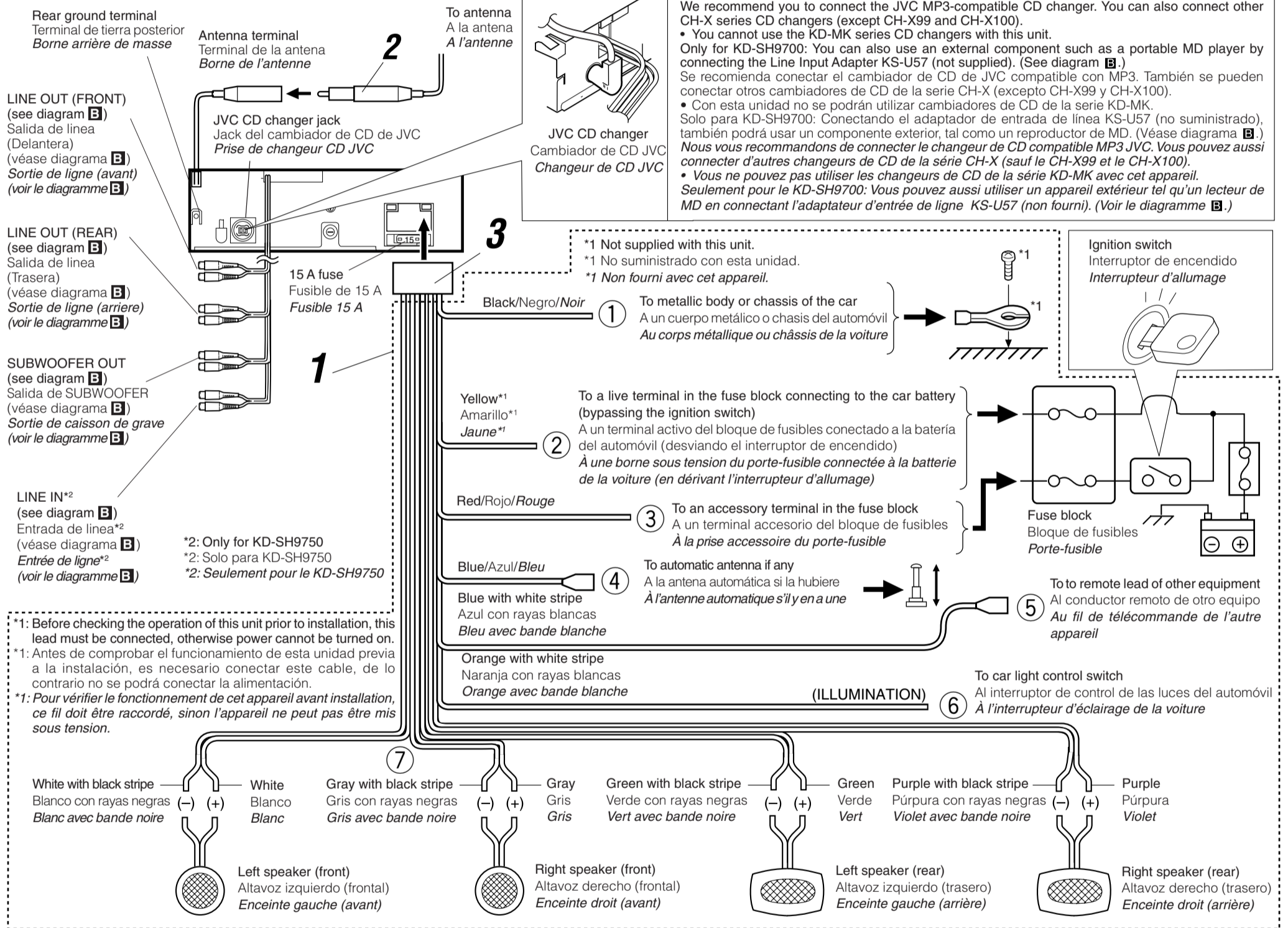

**PRECAUTIONS on power supply and speaker connections:**

- DO NOT connect the speaker leads of the power cord to the car battery; otherwise, the unit will be seriously damaged.
- Connect the black lead (ground), yellow lead (to car battery, constant 12 V), and red lead (to an accessory terminal) correctly.
- BEFORE connecting the speaker leads of the power cord to the speakers, check the speaker wiring in your car.
  - If the speaker wiring in your car is as illustrated in Fig. 1 and Fig. 2 below, DO NOT connect the unit using that original speaker wiring. If you do, the unit will be seriously damaged. Redo the speaker wiring so that you can connect the unit to the speakers as illustrated in Fig. 3.
  - If the speaker wiring in your car is as illustrated in Fig. 3, you can connect the unit using the original speaker wiring in your car.
  - If you are not sure of the speaker wiring of your car, consult your car dealer.

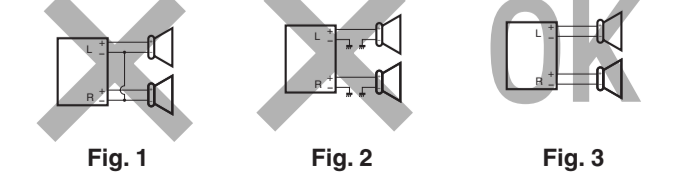

**PRECAUCIONES sobre las conexiones de la fuente de alimentación y de los altavoces:**

- NO conecte los conductores de altavoz del cable de alimentación a la batería de automóvil, pues podrían producirse graves daños en la unidad.
- Conecte correctamente el conductor negro (a tierra), el conductor amarillo (a la batería del automóvil, 12 V constantes), y el conductor rojo (a un terminal de accesorio).
- ANTES de conectar a los altavoces los conductores de altavoz del cable de alimentación, verifique el conexionado de altavoz de su automóvil.
  - Si el conexionado de altavoz de su automóvil es como se indica en las Fig. 1 y Fig. 2 de abajo, NO conecte la unidad utilizando ese conexionado de altavoz original. Si lo hace, se producirán daños graves en la unidad. Vuelva a efectuar el conexionado de altavoz de manera que pueda conectar la unidad a los altavoces de la manera indicada en la Fig. 3.
  - Si el conexionado de altavoz de su automóvil es como se indica en la Fig. 3, podrá conectar la unidad utilizando el conexionado de altavoz original de su automóvil.
  - Si tiene dudas sobre el conexionado de altavoz de su automóvil, consulte con su concesionario.

**PRECAUTIONS sur l'alimentation et la connexion des enceintes:**

- NE CONNECTEZ PAS les fils d'enceintes du cordon d'alimentation à la batterie; sinon, l'appareil serait sérieusement endommagé.
- Connectez correctement le fil noir (a la masse), le fil jaune (a la batterie de la voiture, 12 V constant) et le fil rouge (à la prise accessoire).
- AVANT de connecter les fils d'enceintes du cordon d'alimentation aux enceintes, vérifiez le câblage des enceintes de votre voiture.
  - Si le câblage des enceintes de votre voiture est réalisé comme montré sur la Fig. 1 ou Fig. 2 ci-dessous, NE CONNECTEZ PAS l'appareil en utilisant ce câblage original d'enceintes. Si vous le faites, l'appareil sera sérieusement endommagé. Recommencez le câblage des enceintes de façon que vous puissiez connecter l'appareil aux enceintes comme montré sur la Fig. 3.
  - Si le câblage des enceintes de votre voiture est comme montré sur la Fig. 3, vous pouvez connecter l'appareil en utilisant ce câblage original d'enceintes pour votre voiture.
  - Si vous n'êtes pas sûrs du câblage d'enceintes de votre voiture, consultez le concessionnaire de votre voiture.

## Connecting the leads / Conexión de los conductores / Raccordement des fils

Twist the core wires when connecting.  
Retuerza los alambres de alma para conectarlos.  
Torsader les âmes des fils en les raccordant.

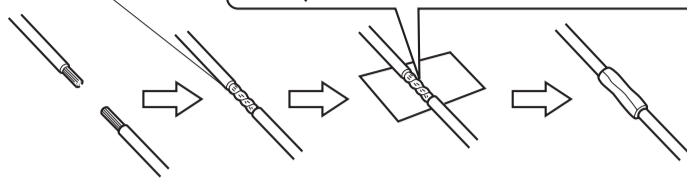

Solder the core wires to connect them securely.  
Suelde los alambres de alma para conectarlos con firmeza.  
Souder les âmes des fils pour les raccorder entre eux de façon sûre.

### CAUTION / PRECAUCION / PRECAUTION:

- To prevent short-circuit, cover the terminals of the UNUSED leads with insulating tape.
- Para evitar cortocircuitos, cubra los cables NO UTILIZADOS con cinta aislante.
- Pour éviter les court-circuits, couvrir les bornes des fils qui ne sont PAS utilisés avec de la bande isolante.

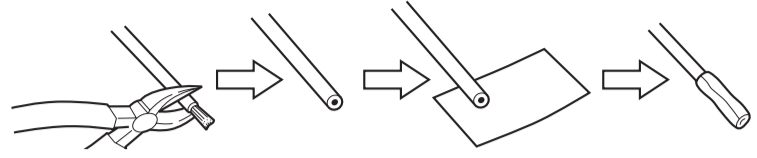

## B Connections Adding Other Equipment / Conexiones para añadir otros equipos / Raccordement pour ajouter d'autres appareils

You can connect an amplifier and other equipment to upgrade your car stereo system.

- Connect the remote lead (blue with white stripe) to the remote lead of the other equipment so that it can be controlled through this unit.
- For amplifier:
  - Connect this unit's line-out terminals to the amplifier's line-in terminals.
  - Disconnect the speakers from this unit, connect them to the amplifier. Leave the speaker leads of this unit unused.**
  - You can switch off the built-in amplifier and send the audio signals only to the external amplifier(s) to get clear sounds and to prevent internal heat built-up inside the unit. See page 42 of the Instructions (separate volume).
  - Only for KD-SH9750: The line output level of this unit is kept high to maintain the hi-fi sounds reproduced from this unit.

Usted podrá conectar un amplificador y otros equipos para mejorar el sistema estéreo de su automóvil.

- Conecte el conductor remoto (azul con rayas blancas) al conductor remoto del otro equipo para poderlo controlar a través de esta unidad.
  - Para el amplificador:
    - Conecte los terminales de salida de línea de esta unidad a los terminales de entrada de línea del amplificador.
    - Desconecte los altavoces de esta unidad y conéctelos al amplificador. Deje los conductores de los altavoces de esta unidad sin usar.**
    - Podrá desconectar el amplificador incorporado y enviar las señales de audio solamente al(los) amplificador(es) externo(s) para obtener sonidos nítidos y evitar que se caliente el interior de la unidad. Véase la página 42 de las instrucciones (volumen separado).
    - Solo para KD-SH9750: El nivel de salida de línea de esta unidad permanece alto para que corresponda con los sonidos de alta fidelidad reproducidos por esta unidad.
- Quando conecte un amplificador externo a esta unidad, disminuya el control de ganancia del amplificador externo para obtener un óptimo rendimiento de esta unidad.**

Vous pouvez connecter un amplificateur ou autre appareil pour améliorer votre système autoradio.

- Connectez le fil de commande à distance (bleu avec bande blanche) au fil de commande à distance de l'autre appareil de façon qu'il puisse être commandé via cet appareil.
  - Pour l'amplificateur:
    - Raccorder les fiches de sortie ligne de cet appareil aux fiches d'entrée ligne de l'amplificateur.
    - Déconnectez les enceintes de cet appareil et connectez-les à l'amplificateur. Laissez les fils d'enceintes de cet appareil inutilisés.**
    - Vous pouvez désactiver l'amplificateur intégré et envoyer les signaux audio uniquement à un ou plusieurs amplificateurs extérieurs afin d'obtenir un son clair et pour éviter un échauffement interne de l'appareil. Référez-vous à la page 42 du mode d'emploi (volume séparé).
    - Seulement pour le KD-SH9750: Le niveau de sortie de ligne de cet appareil est maintenu à un niveau élevé pour maintenir une qualité Hi-Fi pour les sons reproduits par cet appareil.
- Lors de la connexion d'un amplificateur extérieur à cet appareil, diminuez le réglage du gain sur l'amplificateur extérieur pour obtenir les meilleures performances de cet appareil.**

## Amplifier / Amplificador / Amplificateur

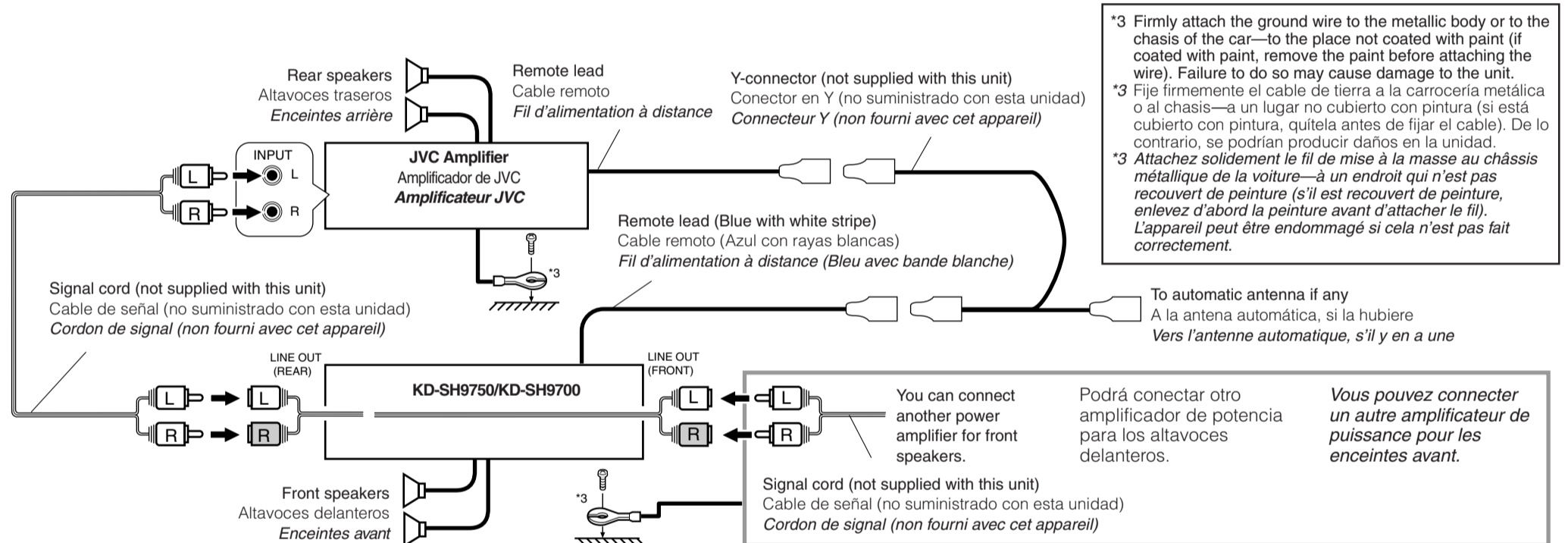

## Subwoofer (SUB WOOFEROUT) / Subwoofer (Salida de SUBWOOFER) / Caisson de grave (Sortie de caisson de grave)

You can connect a subwoofer through an amplifier to reinforce the bass.

- For their connections, refer to the instructions supplied with your subwoofer.

Usted podrá conectar un subwoofer a través de un amplificador para reforzar los graves.

- Con respecto a sus conexiones, refiérase a las instrucciones suministradas con sus subwoofer.

Vous pouvez connecter un caisson de grave par un amplificateur pour renforcer les graves.

- Pour la connexion, référez-vous aux instructions fournies avec le caisson de grave.

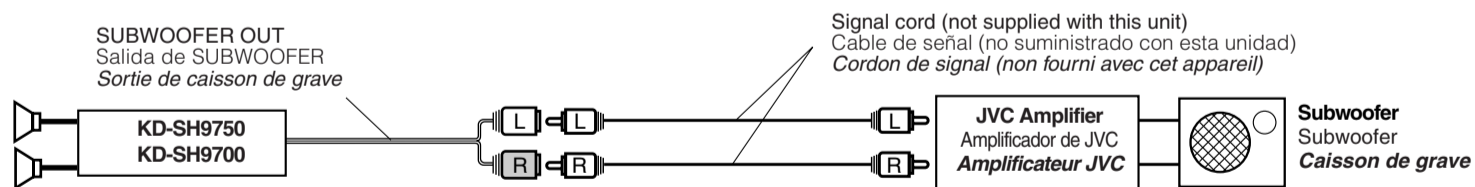

## External component / Componente exterior / Appareil extérieur

### FOR KD-SH9750/PARA KD-SH9750/POUR LE KD-SH9750

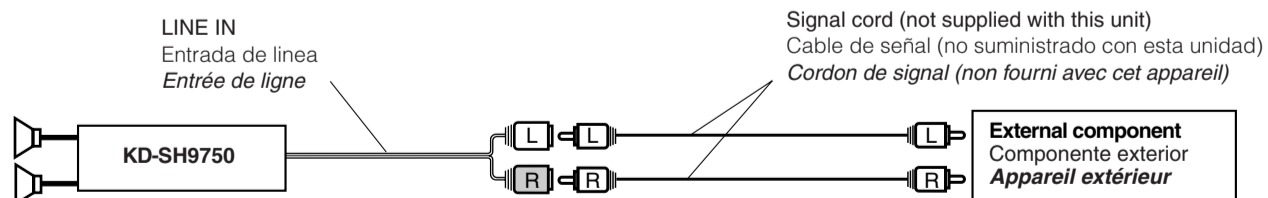

### FOR KD-SH9700/PARA KD-SH9700/POUR LE KD-SH9700

Line Input Adaptor KS-U57 (not supplied with this unit)  
Adaptador de entrada de línea KS-U57 (no suministrado con esta unidad)  
Adaptateur d'entrée de ligne KS-U57 (non fourni avec cet appareil)

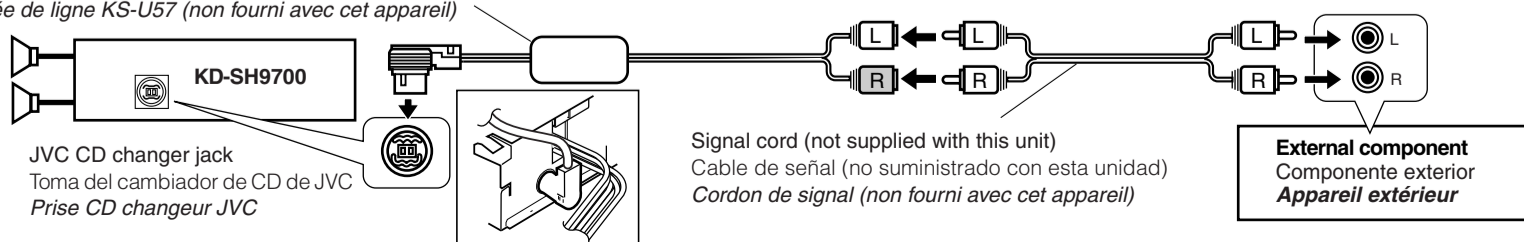



## ENGLISH

### A Guide to MP3/WMA

#### ▶ What are MP3/WMA?

MP3 (MPEG Audio Layer 3) is one of digital audio compression standards.

- This player cannot play back MP3i and MP3 PRO formats.

WMA (Windows Media® Audio) is the digital audio compression format developed by Microsoft Corporation. WMA formatted files copy-protected with DRM cannot be decoded and played on this product.

- This player cannot play back WMA files that are encoded with the following methods:
  - Lossless
  - Professional
  - Voice

**IMPORTANT:** Some players cannot play back WMA files. Such players skip WMA files. For in-depth information, see the instruction supplied with your car audio.

#### ▶ About Tag of MP3/WMA

This player can show the names of albums, artists (performer), and tracks of MP3/WMA Tag.

- This player can handle only one-byte characters. Any other characters cannot be correctly displayed.

#### ▶ About formats of MP3/WMA

This player cannot play back the following files:

- MP3/WMA files without extensions such as [.MP3] or [.WMA].
- MP3/WMA files with the extensions other than [.MP3] or [.WMA].
- Files which do not have MP3/WMA data.
- MP3/WMA files are not encoded in an appropriate format. (this player skips the files after “Unplayable File” appears on the display).
- MP3 files encoded with Layer1/2 (this player skips the files after “Unplayable File” appears on the display).
- WMA files which are not based upon Windows Media® Audio.
- WMA formatted files copy-protected with DRM (this player skips the files after “Unplayable File” appears on the display).
- Files which have the data such as WAVE, ATRACK3, etc.

#### ▶ About available formats of disc

This player cannot play back the following cases:

- CD-R/RW on which the files are written with “Packet Write” method.
- There are improper recording conditions (missing data, etc.) or media conditions (stain, scratch, warp, etc.).
- There are unclosed sessions on CD-R/RW (this player skips unclosed sessions).

#### ▶ About functions restrained during MP3/WMA playback

- The search function works but search speed is not constant during search.
- When skip is tried at the last file in a folder, the next folder is selected.

#### ▶ Glossary

##### CD-DA

The data of music CD

##### Mixed-CD

A CD-R/RW on which audio tracks (CD-DA data) have been added to data tracks before closing a session.

##### Enhanced-CD

A CD-R/RW on which data tracks have been added to audio tracks (CD-DA data) before closing a session.

##### Multiple session

A CD-writing method, which make it possible to add data on a CD-R/RW after closing a session.

Microsoft and Windows Media are either registered trademarks or trademarks of Microsoft Corporation in the United States and/or other countries.

## ESPAÑOL

### Una guía sobre MP3/WMA

#### ▶ ¿Qué es MP3/WMA?

MP3 (MPEG Audio Layer 3) es una de las normas de compresión de audio digital.

- Los formatos MP3i y MP3 PRO no se encuentran disponibles.

WMA (Windows Media® Audio) es el formato de compresión de audio digital desarrollado por Microsoft Corporation. Los archivos formateados WMA protegidos contra la copia por DRM, no pueden ser decodificados ni reproducidos en este producto.

- Los archivos WMA protegidos contra copia y el método Lossless no se encuentran disponibles:
  - Lossless (Sin pérdida)
  - Profesional
  - Voice

**IMPORTANTE:** Algunos reproductores no pueden reproducir archivos WMA. Estos reproductores omiten los archivos WMA. Para una información más detallada, consulte las instrucciones suministradas con su car audio.

#### ▶ Acerca del Tag para MP3/WMA

Este reproductor puede mostrar los nombres de los álbumes, artistas (ejecutantes), y pistas del Tag para MP3/WMA.

- Este reproductor puede manejar solamente caracteres de un byte. Los demás caracteres no serán visualizados correctamente.

#### ▶ Acerca de los formatos disponibles con MP3/WMA

Este reproductor no puede reproducir los archivos siguientes:

- Archivos MP3/WMA que no tengan las extensiones [.MP3] o [.WMA].
- Archivos MP3/WMA con otras extensiones que no sean [.MP3] o [.WMA].
- Archivos que no tengan datos MP3/WMA.
- Los archivos MP3/WMA no están codificados en un formato apropiado. (este reproductor omitirá los archivos después que aparezca “Unplayable File” en la pantalla).
- Archivos MP3 codificados con Layer1/2 (este reproductor omitirá los archivos después que aparezca “Unplayable File” en la pantalla).
- Archivos WMA que no se basan en Windows Media® Audio.
- Archivos formateados WMA protegidos contra la copia por DRM (este reproductor omitirá los archivos después que aparezca “Unplayable File” en la pantalla).
- Archivos que disponen de datos tales como WAVE, ATRACK3, etc.

#### ▶ Acerca de los formatos de discos disponibles

Este reproductor no podrá efectuar la reproducción en los casos siguientes:

- CD-R/RW cuyos archivos están escritos con el método “Packet Write” (escritura por paquetes).
- Condiciones inadecuadas de grabación (datos faltantes, etc.) o del medio (manchas, rayaduras, alabeo, etc.).
- Hay sesiones sin cerrar en el CD-R/RW (este reproductor omite las sesiones sin cerrar).

#### ▶ Acerca de las funciones inhibidas durante la reproducción de MP3/WMA

- Es posible activar la función de búsqueda, pero la velocidad de búsqueda no se mantiene constante.
- Cuando se intente omitir en el último archivo de una carpeta, se seleccionará la siguiente carpeta.

#### ▶ Glosario

##### CD-DA

Datos de un CD de música

##### Mixed-CD

Un CD-R/RW con pistas de audio (datos de CD-DA) añadidas a las pistas de datos antes de cerrar una sesión.

##### Enhanced-CD

Un CD-R/RW al que se han añadido pistas de audio (datos de CD-DA) antes de cerrar una sesión.

##### Multiple session

Un método de escritura de CD, que hace posible añadir datos a un CD-R/RW después de cerrar una sesión.

Microsoft y Windows Media son marcas registradas o bien marcas comerciales de Microsoft Corporation en los Estados Unidos y/u otros países.

## FRANÇAIS

### Un guide du format MP3/WMA

#### ▶ Qu'est-ce que le format MP3/WMA?

MP3 (Norme MPEG Audio de Layer 3) est une des normes de compression audio numérique.

- Ce lecteur ne peut pas reproduire les formats MP3i et MP3 PRO.

WMA (Windows Media® Audio) est le format de compression audio numérique mis au point par Microsoft Corporation. Les fichiers WMA avec protection contre les copies DRM ne peuvent pas être décodés ni reproduits sur cet appareil.

- Ce lecteur ne peut pas reproduire les fichiers WMA codés avec une des méthodes suivantes:
  - Sans perte de qualité
  - Professionnel
  - Voix

**IMPORTANT:** Certains lecteurs ne peuvent pas reproduire les fichiers WMA. Ces lecteurs sauteront ces fichiers. Pour des informations plus détaillées, référez-vous au mode d'emploi fourni avec votre autoradio.

#### ▶ À propos des balises MP3/WMA

Ce lecteur affiche le nom des albums, des artistes (interprète) et des plages des balises MP3/WMA.

- Ce lecteur peut prendre en charge uniquement les caractères d'un octet. Tous les autres caractères ne peuvent pas être affichés correctement.

#### ▶ À propos des formats MP3/WMA

Ce lecteur ne peut pas reproduire les fichiers suivants:

- Les fichiers MP3/WMA sans extension telle que [.MP3] ou [.WMA].
- Les fichiers MP3/WMA avec une extension différente que [.MP3] ou [.WMA].
- Les fichiers qui ne contiennent pas de données MP3/WMA.
- Les fichiers MP3/WMA ne sont pas codés dans le format approprié. (ce lecteur saute ces fichiers après que “Unplayable File” apparaisse sur l'affichage).
- Les fichiers MP3 codés avec le Layer 1/2 (ce lecteur saute ces fichiers après que “Unplayable File” apparaisse sur l'affichage).
- Les fichiers WMA qui ne sont pas basés sur Windows Media® Audio.
- Les fichiers WMA avec protection contre les copies DRM (ce lecteur saute ces fichiers après que “Unplayable File” apparaisse sur l'affichage).
- Les fichiers avec des données telles que WAVE, ATRACK3, etc.

#### ▶ À propos des formats de disque disponibles

Ce lecteur ne peut pas reproduire les disques dans les cas suivants:

- Les CD-R/RW sur lesquels les fichiers ont été écrits avec la méthode “Packet Write” (écriture par paquet).
- Il y a eu des conditions d'enregistrement incorrectes (données manquantes, etc.) ou le support est en mauvaise condition (tâché, rayé, gondolé, etc.)
- Une session sur le CD-R/RW n'a pas été fermée (ce lecteur saute les sessions non fermées).

#### ▶ À propos des fonctions réduites pendant la lecture MP3/WMA

- La fonction de recherche fonctionne mais la vitesse de recherche n'est pas constante.
- Quand vous essayez d'utiliser la fonction de saut pour le dernier fichier d'un dossier, le dossier suivant est choisi.

#### ▶ Glossaire

##### CD-DA

Les données des CD musicaux

##### Mixed-CD (CD mixé)

Des plages audio (données CD-DA) ont été ajoutées aux plages de données d'un CD-R/RW avant la fermeture d'une session.

##### Enhanced-CD (CD amélioré)

Des plages de données ont été ajoutées aux plages audio (données CD-DA) d'un CD-R/RW avant la fermeture d'une session.

##### Multiple session (Session multiple)

Une méthode d'écriture de CD qui permet d'ajouter des données sur un CD-R/RW après la fermeture d'une session.

Microsoft et Windows Media sont des marques déposées ou des marques de commerce de Microsoft Corporation aux États-Unis et/ou dans les autres pays.

**Table of playable disc types / Tabla de los tipos de discos reproducibles / Tableau des types de disque reproductibles**

○: Compatible / Compatibles / Compatible

	KD-LH3150, KD-LH3100 (compatible with only MP3 files) / (compatibles solamente para archivos MP3) / (compatible uniquement avec les fichiers MP3)	KD-SH9750, KD-SH9700 (compatible with both MP3 and WMA files) / (compatible con ambos archivos MP3 y WMA) / (compatible à la fois avec les fichiers MP3 et WMA)
Discs containing both MP3 files and WMA files / Discos conteniendo tanto archivos MP3 como archivos WMA / Disques contenant à la fois des fichiers MP3 et WMA	MP3 playback / Reproducción de MP3 / <i>Lecteur MP3</i>	○
<b>Mixed-CD</b>	MP3 playback / Reproducción de MP3 / <i>Lecture MP3</i>	
<b>MP3 + CD-DA</b>	MP3 playback / Reproducción de MP3 / <i>Lecture MP3</i>	
<b>WMA + CD-DA</b>	CD-DA playback / Reproducción de CD-DA / <i>Lecture CD-DA</i>	WMA playback / Reproducción de WMA / <i>Lecteur WMA</i>
<b>MP3/WMA + CD-DA</b>	MP3 playback / Reproducción de MP3 / <i>Lecture MP3</i>	MP3/WMA playback / Reproducción de MP3/WMA / <i>Lecture MP3/WMA</i>
<b>Other files + CD-DA / Otros archivos + CD-DA / Autres fichiers + CD-DA</b>	CD-DA playback / Reproducción de CD-DA / <i>Lecture CD-DA</i>	
<b>Enhanced CD</b>	CD-DA playback / Reproducción de CD-DA / <i>Lecture CD-DA</i>	
<b>File name system / Sistema de nombre de archivo / Système de noms de fichiers</b>	Up to 12 characters (8.3 format) / Hasta 12 caracteres (formato 8,3) / <i>12 caractères maximum (format 8,3)</i>	
<b>ISO9660 Level1 / Level1 / Niveau1</b>	Up to 31 characters / Hasta 31 caracteres / <i>31 caractères maximum</i>	
<b>ISO9660 Level2 / Level2 / Niveau2</b>	Not available / No disponible / <i>Non disponible</i>	
<b>ISO9660 Level3 / Level3 / Niveau3</b>	Up to 128 characters / Hasta 128 caracteres / <i>128 caractères maximum</i>	
<b>Romeo</b>	Up to 64 characters / Hasta 64 caracteres / <i>64 caractères maximum</i>	
<b>Joliet</b>	Up to 128 characters / Hasta 128 caracteres / <i>128 caractères maximum</i>	
<b>Windows long file name / Norma de archivo largo Windows / Nom de fichier long Windows</b>	Up to 128 characters / Hasta 128 caracteres / <i>128 caractères maximum</i>	
<b>Multiple session / Sesión múltiple / Session multiple</b>	○	
<b>80-minute discs (capacity: 700 MB) / Discos de 80 minutos (capacidad: 700MB) / Disques de 80 minutes (capacité: 700 Mo)</b>	○	

- Maximum number of characters for file/folder names includes 4 extension characters—“.MP3” or “.WMA.”
- El número máximo de caracteres para los nombres de archivos/carpetas incluye 4 caracteres de extensión—.MP3” o “.WMA”.
- Le nom maximum de caractères pour les noms de fichier/dossier comprend les 4 caractères de l'extension—.MP3” ou “.WMA”.

**Table for playable MP3/WMA files / Tabla de archivos MP3/WMA reproducibles / Tableau des fichiers MP3/WMA reproductibles**

○: Compatible / Compatibles / Compatible

	KD-LH3150, KD-LH3100 (compatible with only MP3 files) / (compatibles solamente para archivos MP3) / (compatible uniquement avec les fichiers MP3)	KD-SH9750, KD-SH9700 (compatible with both MP3 and WMA files) / (compatible con ambos archivos MP3 y WMA) / (compatible à la fois avec les fichiers MP3 et WMA)
<b>WMA playback / Reproducción WMA / WMA playback</b>	Not playable / No reproducible / <i>Non reproductible</i>	○
<b>MP3</b>	8 kbps—320 kbps	
<b>Bit-rate / Velocidad de bit / Débit binaire</b>	8 kbps—320 kbps	
<b>VBR</b>	○	
<b>Sampling frequency / Frecuencia de muestreo / Fréquence d'échantillonnage</b>	<b>MPEG-1</b>	48 kHz, 44.1 kHz, 32 kHz
	<b>MPEG-2</b>	24 kHz, 22.05 kHz, 16 kHz
<b>Joint stereo / Joint Stereo / Mode stéréo combiné</b>	○	
<b>Emphasis / Emphasis / Accentuation</b>	○	
<b>ID3-Tag / ID3-Tag / Balise ID3</b>	Ver. 1.0, 1.1, 2.2, 2.3, 2.4	
<b>WMA</b>	Not available / No disponible / <i>Non disponible</i>	32 kbps—192 kbps
<b>Bit-rate / Velocidad de bit / Débit binaire</b>	Not available / No disponible / <i>Non disponible</i>	32 kbps—192 kbps
<b>Sampling frequency / Frecuencia de muestreo / Fréquence d'échantillonnage</b>	Not available / No disponible / <i>Non disponible</i>	48 kHz, 44.1 kHz, 32 kHz, 22 kHz
<b>WMA-Tag</b>	Not available / No disponible / <i>Non disponible</i>	○
<b>m3u playlist / m3u playlist / Playlist m3u</b>	Not available / No disponible / <i>Non disponible</i>	
<b>Manual search / Búsqueda manual / Recherche manuelle</b>	○ (Search speed is not constant. / La velocidad de búsqueda no es constante. / <i>La vitesse de recherche n'est pas constante.</i> )	
<b>Maximum number of folder hierarchy / Número máximo de jerarquía de carpetas / Nombre maximum de hiérarchies de dossiers</b>	8	
<b>Maximum number of files/folders / Número máximo de archivos/carpetas / Nombre maximum de fichiers/dossiers</b>	Files on each folder / Archivos en cada carpeta / Fichiers dans chaque dossier	255
	Folders on a disc / Carpetas en un disco / Dossiers dans un disque	100
	Total / Total / Total	460
<b>Maximum number of characters on the display / Número máximo de caracteres en la pantalla / Nombre maximum de caractères sur l'affichage</b>	128 (including [.MP3]) (incluyendo [.MP3]) (incluant [.MP3])	128 (including [.MP3] or [.WMA]) (incluyendo [.MP3] o [.WMA]) (incluant [.MP3] ou [.WMA])
<b>Playback order / Orden de reproducción / Ordre de lecture</b>	In the order of hierarchy / En el orden de la jerarquía / <i>Dans l'ordre des hiérarchies</i>	

**► Questions and Answers**

**An MP3/WMA disc requires a long readout time...?**

When an MP3/WMA disc is inserted, information inside the disc (number of folders and files, and positions of data) is first read.

So, in the following cases, a fairly long time may be needed before playback starts:

- If the file structure is complicated,
- If the number of files is large, or
- If the number of sessions is large (in case of multi-session discs).

**There occurs sound interruption or sound skipping...?**

Sound interruption or sound skipping may occur, depending on recording conditions (missing data, etc.) or media conditions (stain, scratch, warp, etc.).

**MP3/WMA files are not played back in an intended order...?**

This player plays back MP3/WMA files in order of hierarchy levels.

- The playback order may differ from your intended order because of your writing software.

**Elapsed playing time is not displayed correctly...?**

Files recorded in VBR (variable bit rate) have a discrepancy in elapsed time display, and do not show the actual passage of time. Especially, after performing the search function, this difference becomes noticeable.

**► Preguntas y respuestas**

**¿Un disco MP3/WMA requiere un mayor tiempo de lectura...?**

Cuando se inserta un disco MP3/WMA, primero se lee la información contenida dentro del disco (número de carpetas y archivos, y posiciones de los datos).

Por lo tanto, en los siguientes casos, es posible que se tarde un poco antes de iniciarse la reproducción:

- Si la estructura del archivo es complicado,
- Si el número de archivos es grande,
- Si el número de sesiones es grande (en caso de discos de múltiples sesiones).

**¿Ocurre la interrupción de sonido o la omisión de sonido...?**

Puede producirse interrupción u omisión de sonido, dependiendo de las condiciones de grabación (datos faltantes, etc.) o del medio (manchas, rayaduras, alabeo, etc.).

**¿Los archivos MP3/WMA no se reproducen en el orden previsto...?**

Este reproductor reproduce los archivos MP3/WMA en el orden de los niveles de jerarquía.

- El orden de reproducción puede ser distinto del orden previsto debido a su software de escritura.

**¿El tiempo transcurrido no se visualiza correctamente...?**

Los archivos grabados en VBR (velocidad de bit variable) presentan discrepancia en la visualización del tiempo transcurrido, y no visualizan exactamente el tiempo que transcurre. Especialmente, esta diferencia se vuelve más evidente después de realizar la función de búsqueda.

**► Questions et réponses**

**Le temps d'initialisation d'un disque MP3/WMA est plus long...?**

Quand un disque MP3/WMA est inséré, les informations dans le disque (nombre de dossiers et de fichiers, position des données) sont lues.

Dans les cas suivants, un temps plus long peut être nécessaire avant que la lecture démarre:

- Si la structure des fichiers est compliquée.
- Si le nombre de fichiers est grand.
- Si le nombre de sessions est grand (dans le cas d'un disque multi sessions).

**Il y a des interruptions de son ou le son est sauté...?**

Des interruptions du son ou des sauts dans la lecture peuvent se produire en fonction des conditions d'enregistrement (données manquantes, etc.) ou des conditions du support (saleté, rayure, disque gondolé, etc.).

**Les fichiers MP3/WMA ne sont pas reproduits dans l'ordre souhaité...?**

Ce lecteur reproduit les fichiers MP3/WMA dans l'ordre des niveaux de hiérarchie.

- L'ordre de lecture peut différer de l'ordre souhaité à cause du logiciel de gravure.

**La durée de lecture écoulée n'est pas affichée correctement...?**

Les fichiers enregistrés en mode VBR (débit binaire variable) ont une différence dans l'affichage de la durée de lecture écoulée et n'affiche pas le temps du passage actuel. Plus spécialement, la différence devient importante après l'utilisation de la fonction de recherche.

Notice the following information will help you to solve your problems.  
Keep this IMPORTANT sheet together with the INSTRUCTIONS.

- **After installing the unit**

- Follow the procedure **A** described below.

- **If the unit does not operate**

- Follow the procedure **A** described below.

- **If a disc is not ejected from the loading slot**

- Follow the procedure **B** described below. (If the procedure **B** does not work, try the procedure **A**.)

- **If a disc is not recognized ("No Disc," "Loading Error," or "Eject Error" flashes on the display) even though there is a disc in the loading slot**

- Follow the procedure **B** described below. (If the procedure **B** does not work, try the procedure **A**.)

**A To reset the microcomputer**

Press the reset button on the control panel using a ball-point pen or similar tool.  
This will reset the built-in microcomputer.

**NOTE:** Your preset adjustments—such as preset channels or sound adjustments—will also be erased.

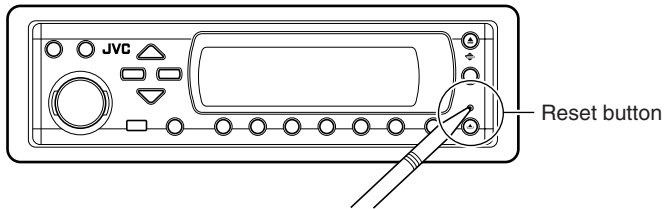

**B To eject a disc by force**

While holding  $\phi$ /I ATT, press and hold  $\blacktriangle$  for more than 2 seconds.  
(Be careful not to drop the disc when it is ejected.)

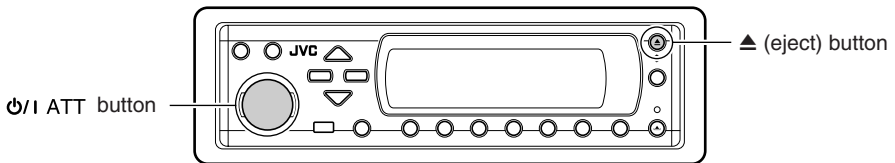



# Addendum/Addenda/Addenda

---

## English

Page 37

### Activating the downloaded images and animations

---

To activate the animations stored for opening and ending screens

- Opening and ending screens will not be shown if the “KeyIn CFM” setting is set to “Short” or “Off.” (See page 41).

## Español

Página 37

### Activación de imágenes y animaciones descargadas

---

Cómo activar las animaciones almacenadas para las pantallas de apertura y de fin

- Las pantallas de apertura y de cierre no se visualizarán si el ajuste “KeyIn CFM” se encuentra ajustado a “Short” o “Off”. (Consulte la página 41).

## Français

Page 37

### Mise en service des images et animations transférées

---

Pour mettre en service les animations mémorisées pour les écrans d'ouverture et de fermeture

- L'écran d'ouverture et de fermeture n'apparaît pas si le réglage “KeyIn CFM” est réglé sur “Short” ou “Off”. (Voir la page 41.)

# Canceling the display demonstration / Cancelación de la demostración en pantalla / Annulation de la démonstration des affichages / Abbrechen der Display-Demonstration / Annuleren van de displaydemonstratie / Annullamento della demo del display

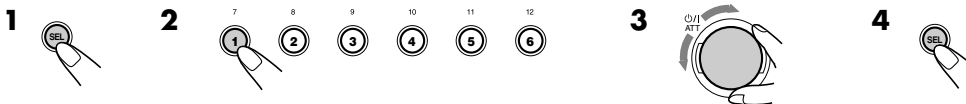

## ENGLISH

When shipped from the factory, display demonstration has been activated, and starts automatically when no operations are done for about 20 seconds.

- It is recommended to cancel the demonstration before you use the unit for the first time.

**To cancel the display demonstration**, follow the procedure below:

- 1 Press and hold SEL (select) for more than 2 seconds so that one of the PSM items appears on the display.
- 2 Press number button 1 to select "MOVIE"—Movie category of the PSM settings.
- 3 Select "Off."
- 4 Finish the setting.

## DEUTSCH

Das Gerät wird werkseitig mit aktivierter Display-Demonstration ausgeliefert, die automatisch startet, wenn ca. 20 Sekunden keine Taste betätigt wird.

- Es wird empfohlen, die Demonstration zu deaktivieren, bevor das Gerät zum ersten Mal verwendet wird.

**Um die Display-Demonstration abubrechen**, gehen Sie bitte nach dem folgenden Verfahren vor:

- 1 Drücken und halten Sie die Taste SEL (Auswahl) länger als 2 Sekunden, so daß eines der PSM-Elemente auf dem Display angezeigt wird.
- 2 Drücken Sie die Zifferntaste 1, um „MOVIE“ auszuwählen—Movie-Kategorie der PSM-Einstellungen.
- 3 Wählen Sie „Off“ aus.
- 4 Beenden Sie die Einstellung.

## ESPAÑOL

La unidad se expide de fábrica con la demostración en pantalla activada para que se inicie automáticamente tras un período de inactividad de 20 segundos.

- Se recomienda cancelar la demostración antes de usar la unidad por primera vez.

**Para cancelar la demostración en pantalla**, siga el procedimiento de abajo.

- 1 Pulse y mantenga pulsado SEL (selección) durante más de 2 segundos para que una de las opciones PSM aparezca en la pantalla.
- 2 Pulse el botón numérico 1 para seleccionar "MOVIE"—Categoría de película de los ajustes de PSM.
- 3 Seleccione "Off".
- 4 Finalice el ajuste.

## NEDERLANDS

Bij het verlaten van de fabriek is de displaydemonstratie geactiveerd en start deze automatisch indien u gedurende ongeveer 20 seconden geen bediening uitvoert.

- Het wordt aanbevolen om de demonstratie te annuleren alvorens het toestel werkelijk in gebruik te nemen.

**Voor het annuleren van de displaydemonstratie**, voert u de volgende handelingen uit:

- 1 Houd SEL (kiezen) langer dan 2 seconden ingedrukt zodat geen van de PSM-onderdelen op het display worden getoond.
- 2 Druk op cijfertoets 1 om "MOVIE"—Filmcategorie van de PSM-instellingen – te kiezen.
- 3 Kies "Off".
- 4 Voltooi de instelling.

## FRANÇAIS

À l'expédition de l'usine, la démonstration des affichages est en service et elle démarre automatiquement quand aucune opération n'est effectuée pendant environ 20 secondes.

- Il est recommandé d'annuler la démonstration avant d'utiliser l'appareil pour la première fois.

**Pour annuler la démonstration**, suivez la procédure ci-dessous.

- 1 Maintenez pressée SEL (sélection) pendant plus de 2 secondes de façon qu'un des réglages PSM apparaisse sur l'affichage.
- 2 Appuyez sur la touche numérique 1 pour choisir—"MOVIE"—Catégorie "Movie" des réglages PSM.
- 3 Choisissez "Off".
- 4 Terminez le réglage.

## ITALIANO

La demo del display è attiva al momento della spedizione e viene avviata automaticamente quando non vengono effettuate operazioni per circa 20 secondi.

- Si consiglia di annullare la demo prima di utilizzare l'unità per la prima volta.

**Per annullare la demo del display**, attenersi alla seguente procedura.

- 1 Premere e tenere premuto SEL (selezione) per più di due secondi per visualizzare un componente PSM sul display.
- 2 Premere il pulsante numerico 1 per selezionare "MOVIE"—Categoria Movie delle impostazioni PSM.
- 3 Selezionare "Off".
- 4 Terminare l'impostazione.